

INTRODUCTION

In view of the recent amendment made in the Designs (Amendment) Rules, 2008 with effect from 17/06/2008, Publication of the matter relating to Designs is being published in the Official Journal of The Patent Office. This Journal is being published on weekly basis on every Friday covering the various proceedings on Designs as required according to the provisions of under Rule 22, 25, 27 and 39 of the Design (Amendment) Rules, 2008. All the enquiries on this Official Journal and other information as required by the public should be addressed to the Controller General of Patents, Designs & Trade Marks. Suggestions and comments are requested from all quarters so that the content can be enriched.

THE DESIGNS ACT, 2000
SECTION 30
DESIGN ASSIGNMENT

The Design stands in the name of DAEYOUNG CHAEVI CO., LTD. & JUNG MIN KYO registered under the Designs Act, 2000 has been assigned in the Register of Designs in the name as follows:-



| Design No. | Class | Name |
|-------------------|--------------|--|
| 300312 | 13-02 | DAEYOUNG CHAEVI CO., LTD. A COMPANY ORGANISED AND EXISTING UNDER THE LAWS OF REPUBLIC OF KOREA OF 25, TECHNO SUNHWAN-RO 7-GIL, YUGA-MYEON, DALSEONG-GUN, DAEGU 43023 REPUBLIC OF KOREA |
| 300313 | 13-02 | |
| 300522 | 13-02 | |

CANCELLATION PROCEEDINGS
Under Section 19 of the Designs Act, 2000 &
under Rule 29(1) of Designs (Amendment) Rules, 2008

“OIL India Limited (Through Shri S K Deka, Chief Manager-Legal), Duliajan, Dibrugarh, Assam-786602 has filed a petition (**Petition No. Can/033/2016**) on 29/04/2016 for cancellation of registration of registered Design No. **241907** dated 28th December, 2011 under class 99-00 titled as ‘PROTECTIVE COVER’ in the name of M/S DAMANI CONSTRUCTION COMPANY WHOSE PROPRIETOR IS MR. MANOHAR FOMRA, BY NATIONALITY INDIAN, HAVING ITS PRINCIPAL PLACE OF BUSINESS AT BE-259, SECTOR-1, SALT LAKE, KOLKATA-700064, WEST BENGAL, INDIA BY NATIONALITY INDIAN.”

REGISTRATION OF DESIGNS

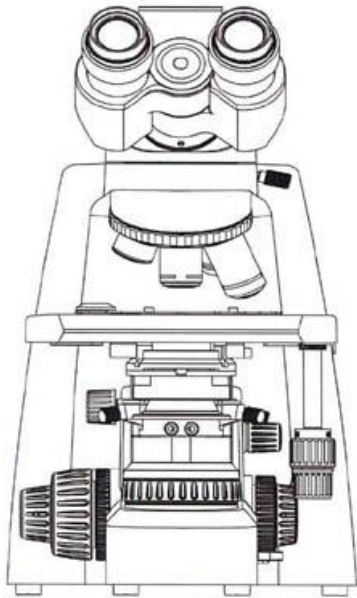
The following designs have been registered. They are now open for public inspection. In the following each entry the Date of Registration is shown. The Priority Number, Priority Date and Priority Country are also shown

| | | | |
|--|-----------------------|----------------|---|
| DESIGN NUMBER | 319566-001 | |  |
| CLASS | 16-06 | | |
| CARL ZEISS MICROSCOPY GMBH, CARL-ZEISS-PROMENADE 10, 07745 JENA, GERMANY. | | | |
| DATE OF REGISTRATION | 11/07/2019 | | |
| TITLE | MICROSCOPE | | |
| PRIORITY | | | |
| PRIORITY NUMBER | DATE | COUNTRY | |
| 201930027095.X | 18/01/2019 | CHINA | |
| DESIGN NUMBER | | | |
| CLASS | 319657-001 | | |
| CLASS | 26-04 | | |
| VIJAY DATT SHARMA, D-73, SECTOR -7, NOIDA-201301, UTTAR PRADESH | | | |
| DATE OF REGISTRATION | 15/07/2019 | | |
| TITLE | LED LIGHT | | |
| PRIORITY NA | | | |
| DESIGN NUMBER | | | |
| CLASS | 319840-001 | |  |
| CLASS | 08-05 | | |
| GRANDPITSTOP PVT. LTD., C-922 A, SUSHANT LOK, C BLOCK, GURGAON – 122002. | | | |
| DATE OF REGISTRATION | 22/07/2019 | | |
| TITLE | TYRE MAINTENANCE TOOL | | |
| PRIORITY NA | | | |

| | | |
|--|--------------------------|----------------|
| DESIGN NUMBER | 310831 | |
| CLASS | 10-04 | |
| ZOZO, INC., 2-6-1, NAKASE, MIHAMA-KU, CHIBA-SHI, CHIBA 2617116 JAPAN. | | |
| DATE OF REGISTRATION | 10/10/2018 | |
| TITLE | BODY SIZE MEASURING TOOL | |
| PRIORITY | | |
| PRIORITY NUMBER | DATE | COUNTRY |
| 2018-009340 | 26/04/2018 | JAPAN |



| | | |
|---|-------------|----------------|
| DESIGN NUMBER | 311129 | |
| CLASS | 23-01 | |
| BEIJING KOHLER LTD., 27 GUOYUAN WEST ROAD, MIYUN COUNTY, BEIJING, CHINA. | | |
| DATE OF REGISTRATION | 17/10/2018 | |
| TITLE | FAUCET | |
| PRIORITY | | |
| PRIORITY NUMBER | DATE | COUNTRY |
| 29/649,780 | 01/06/2018 | U.S.A. |

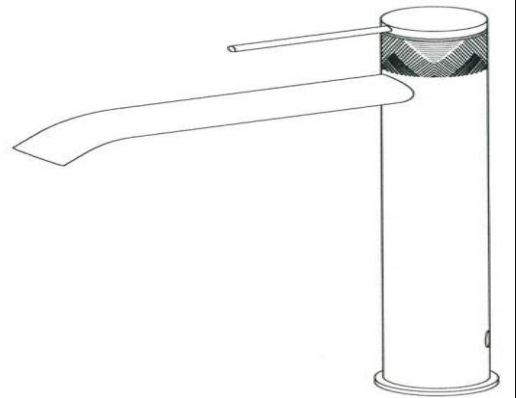

| | | |
|--|----------------------|--|
| DESIGN NUMBER | 311996 | |
| CLASS | 21-01 | |
| ADITIS INNOSOLUTIONS PRIVATE LIMITED, 15/4B, PERIYAR STREET, NEAR RATHNA THEATRE, DHARMAPURI, INDIA-636701. | | |
| DATE OF REGISTRATION | 14/11/2018 | |
| TITLE | TERMINATOR CHESS SET | |
| PRIORITY NA | | |

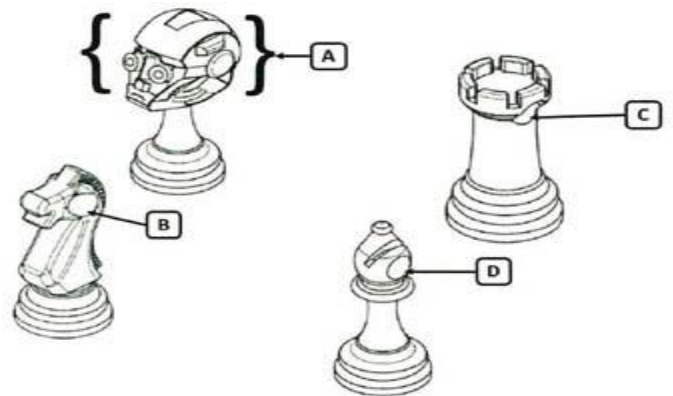

| | | |
|--|---|----------------|
| DESIGN NUMBER | 312109 | |
| CLASS | 14-03 | |
| GENTEX CORPORATION, 324 N. MAIN STREET, SIMPSON, PENNSYLVANIA 18407, USA. | | |
| DATE OF REGISTRATION | 16/11/2018 | |
| TITLE | ATTACHMENT CLIP FOR A COMMUNICATION HEADSET | |
| PRIORITY | | |
| PRIORITY NUMBER | DATE | COUNTRY |
| 29/648,183 | 18/05/2018 | U.S.A. |

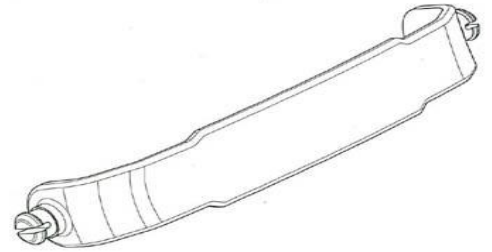



| | | |
|---|------------|--|
| DESIGN NUMBER | 315321-001 | |
| CLASS | 02-04 | |
| CHAIRMAN, DEFENCE RESEARCH & DEVELOPMENT ORGANISATION, MINISTRY OF DEFENCE, GOVERNMENT OF INDIA, ROOM NO. 348, B-WING, DRDO BHAWAN, RAJAJI MARG, NEW DELHI-110105, INDIA | | |
| DATE OF REGISTRATION | 04/03/2019 | |
| TITLE | SHOE SOLE | |
| PRIORITY NA | | |



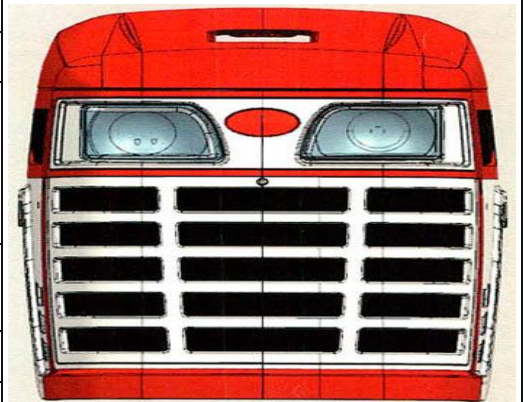

| | | |
|---|--------------|--|
| DESIGN NUMBER | 315390-001 | |
| CLASS | 12-09 | |
| MAHINDRA & MAHINDRA LIMITED, MAHINDRA RESEARCH VALLEY, MAHINDRA WORLD CITY, PLOT NO.41/1, ANJUR P.O., CHENGALPATTU, KANCHIPURAM DISTRICT, TAMIL NADU - 603 004, INDIA. | | |
| DATE OF REGISTRATION | 05/03/2019 | |
| TITLE | TRACTOR HOOD | |
| PRIORITY NA | | |



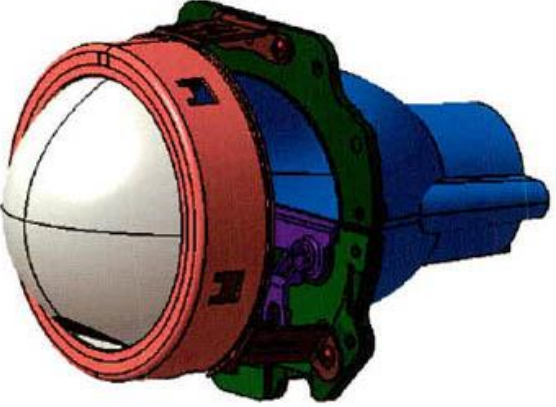

| | | | |
|--|------------------------|----------------|---|
| DESIGN NUMBER | 313865-001 | |  |
| CLASS | 12-15 | | |
| CEAT LIMITED, RPG HOUSE, 463, DR. ANNIE BESANT ROAD, WORLI, MUMBAI 400 030, INDIA. | | | |
| DATE OF REGISTRATION | 15/01/2019 | | |
| TITLE | TYRE | | |
| PRIORITY NA | | | |
| DESIGN NUMBER | 316142-001 | |  |
| CLASS | 06-06 | | |
| KUSH JAWAHAR, C/O., FEATHERLITE PRODUCTS PRIVATE LIMITED AT UNIT III, #18, 19/1, CHOKKANAHALLI VILLAGE, BYATHA ROAD, RAJKUNTE POST, ARAKERE GRAM PANCHAYAT, BENGALURU – 561263, KARNATAKA, INDIA. | | | |
| DATE OF REGISTRATION | 27/03/2019 | | |
| TITLE | BACK REST FOR A CHAIR | | |
| PRIORITY NA | | | |
| DESIGN NUMBER | 280135 | |  |
| CLASS | 12-16 | | |
| AUDI AG, AUTO-UNION-STR. 1, D-85045 INGOLSTADT, GERMANY | | | |
| DATE OF REGISTRATION | 05/02/2016 | | |
| TITLE | WHEEL RIM FOR VEHICLES | | |
| PRIORITY | | | |
| PRIORITY NUMBER | DATE | COUNTRY | |
| 002750489-0002 | 06/08/2015 | OHIM | |

| | | |
|---|------------|---|
| DESIGN NUMBER | 315795-001 |  |
| CLASS | 10-02 | |
| TITAN COMPANY LIMITED, INTEGRITY" NO.193, VEERASANDRA, ELECTRONICS CITY P.O., OFF HOSUR MAIN ROAD, BANGALORE – 560100. | | |
| DATE OF REGISTRATION | 15/03/2019 | |
| TITLE | WATCH | |
| PRIORITY NA | | |

| | | |
|--|---------------------------------------|---|
| DESIGN NUMBER | 316399-002 |  |
| CLASS | 26-06 | |
| MINDA RINDER PVT. LTD., GAT NO-148, MHALUNGE INGLE, OFF. CHAKAN - TALEGAON ROAD, TAL-KHED, DIST.-PUNE, MAHARASHTRA 410501, INDIA. | | |
| DATE OF REGISTRATION | 03/04/2019 | |
| TITLE | BI-FUNCTIONAL PROJECTOR LAMP ASSEMBLY | |
| PRIORITY NA | | |

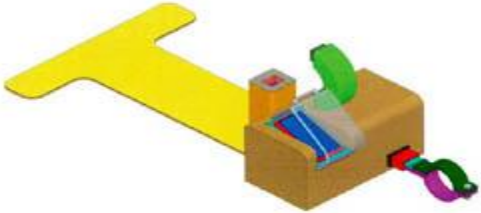
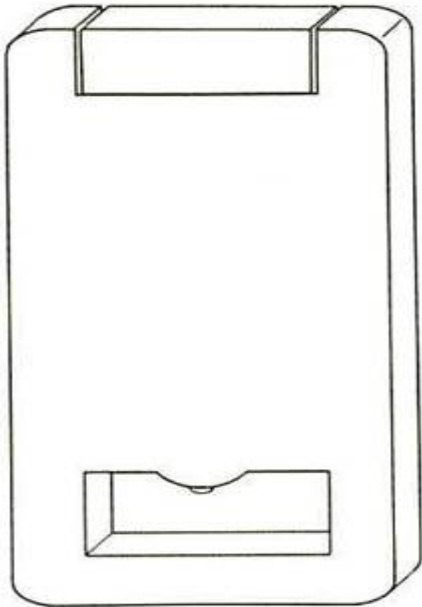
| | | |
|---|----------------|--|
| DESIGN NUMBER | 316636-001 |  |
| CLASS | 06-04 | |
| GODREJ & BOYCE MFG. CO. LTD., GODREJ INTERIO, PLANT 13, PIROJSHANAGAR, VIKHROLI, MUMBAI-400079, INDIA. | | |
| DATE OF REGISTRATION | 09/04/2019 | |
| TITLE | WARDROBE SHELF | |
| PRIORITY NA | | |

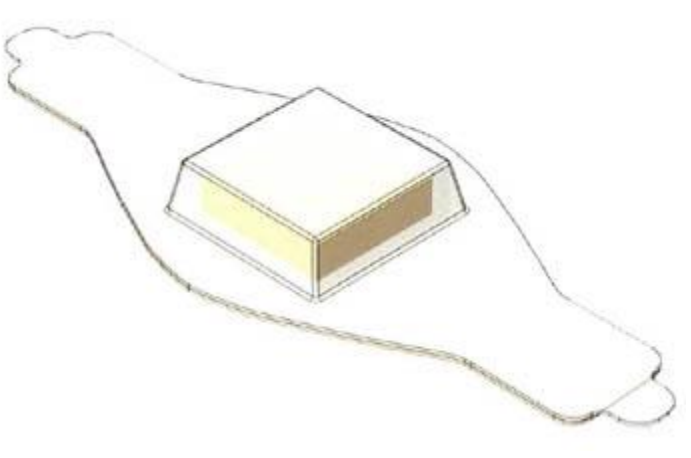
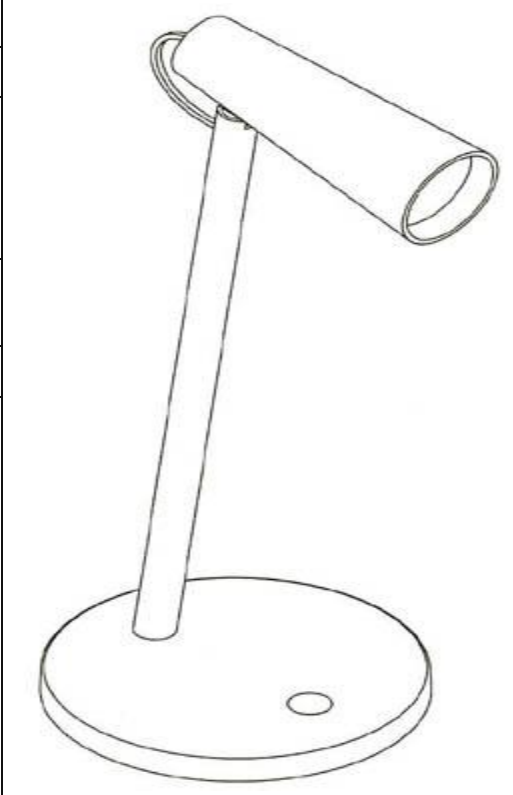
| | | |
|--|--|---|
| DESIGN NUMBER | 316873-001 |  |
| CLASS | 07-01 | |
| UMBERTO CERAMICS INTERNATIONAL PVT LTD, SADOLIYA – GALTESHWAR ROAD, OFF. NATIONAL HIGHWAY NO. 8, PRANTIJ, SABARKANTHA 383205, GUJARAT, INDIA | | |
| DATE OF REGISTRATION | 15/04/2019 | |
| TITLE | BOWL | |
| PRIORITY NA | | |
| DESIGN NUMBER | 316972-002 |  |
| CLASS | 08-07 | |
| SATHYABAMA INSTITUTE OF SCIENCE AND TECHNOLOGY SCHOOL OF MECHANICAL ENGINEERING, JEPPIAAR NAGAR, RAJIV GANDHI SALAI, CHENNAI - 600 119, TAMILNADU, INDIA. | | |
| DATE OF REGISTRATION | 18/04/2019 | |
| TITLE | ELECTRONIC HELMET LOCK FOR TWO-WHEELERS | |
| PRIORITY NA | | |
| DESIGN NUMBER | 326791-001 |  |
| CLASS | 23-02 | |
| ANEES ASHIF PATEL, 204, 2ND FLOOR, 9 - PATEL CHAMBER, RUSTOM SIDHWA MARG, FORT, MUMBAI - 400 001, MAHARASHTRA, INDIA. | | |
| DATE OF REGISTRATION | 05/02/2020 | |
| TITLE | LIQUID SOAP DISPENSER | |
| PRIORITY NA | | |

| | | |
|---|------------|---|
| DESIGN NUMBER | 307441 |  |
| CLASS | 24-04 | |
| AXIO BIOSOLUTIONS PVT. LTD, 99, SHANGRILA, 100FT HEBATPUR ROAD, THALTEJ, AHMEDABAD, PIN -380054, GUJARAT, INDIA. | | |
| DATE OF REGISTRATION | 05/07/2018 | |
| TITLE | BANDAGE | |
| PRIORITY NA | | |
| DESIGN NUMBER | 318163-001 |  |
| CLASS | 26-05 | |
| BEIJING XIAOMI MOBILE SOFTWARE CO., LTD., ROOM 01, FLOOR 9, RAINBOW CITY SHOPPING MALL II OF CHINA RESOURCES, NO. 68, QINGHE MIDDLE STREET, HAIDIAN DISTRICT, BEIJING 100085, CHINA. | | |
| DATE OF REGISTRATION | 28/05/2019 | |
| TITLE | TABLE LAMP | |
| PRIORITY NA | | |
| DESIGN NUMBER | 317356-001 |  |
| CLASS | 21-01 | |
| RENAULT S.A.S, 13-15 QUAI LE GALLO 92100 BOULOGNE BILLANCOURT FRANCE. | | |
| DATE OF REGISTRATION | 30/04/2019 | |
| TITLE | TOY CAR | |
| PRIORITY NA | | |

| | | |
|--|------------------|---|
| DESIGN NUMBER | 317394-003 |  |
| CLASS | 06-01 | |
| HARITA SEATING SYSTEMS LIMITED, JAYALAKSHMI ESTATES, 29 (OLD NO. 8) HADDOWS ROAD, CHENNAI 600 006, TAMIL NADU, INDIA. | | |
| DATE OF REGISTRATION | 02/05/2019 | |
| TITLE | SEAT FOR VEHICLE | |
| PRIORITY NA | | |

| | | |
|--|------------------|----------------|
| DESIGN NUMBER | 306927 | |
| CLASS | 14-03 | |
| GUANGDONG OPPO MOBILE TELECOMMUNICATIONS CORP., LTD., NO. 18, HAIBIN ROAD, WUSHA, CHANG'AN, DONGGUAN, GUANGDONG 523860, PEOPLE'S REPUBLIC OF CHINA. | | |
| DATE OF REGISTRATION | 20/06/2018 | |
| TITLE | COVER FOR MOBILE | |
| PRIORITY | | |
| PRIORITY NUMBER | DATE | COUNTRY |
| 201830076854.7 | 28/02/2018 | CHINA |

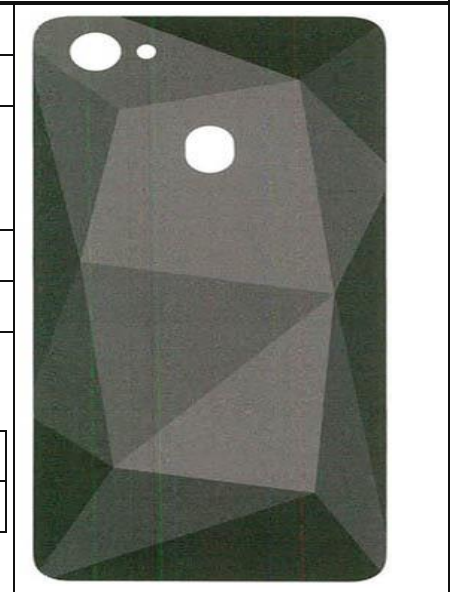

| | | |
|---|--------------------------|-------------------|
| DESIGN NUMBER | 327266-001 | |
| CLASS | 23-04 | |
| SAMSUNG ELECTRONICS CO., LTD., 129, SAMSUNG-RO, YEONGTONG-GU, SUWON-SI, GYEONGGI-DO, REPUBLIC OF KOREA | | |
| DATE OF REGISTRATION | 17/02/2020 | |
| TITLE | AIR PURIFIER FOR VEHICLE | |
| PRIORITY | | |
| PRIORITY NUMBER | DATE | COUNTRY |
| 30-2019-0042429 | 03/09/2019 | REPUBLIC OF KOREA |

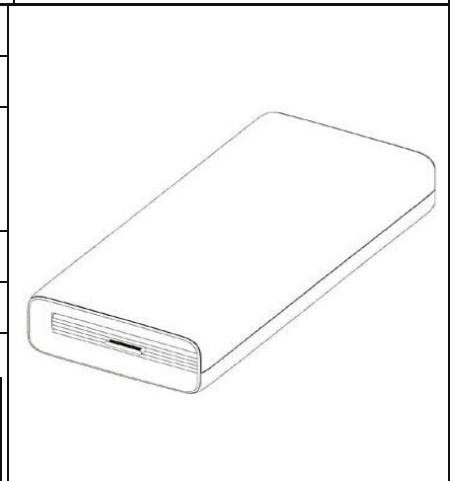

| | | |
|--|---------------------|---|
| DESIGN NUMBER | 327275-001 |  |
| CLASS | 31-00 | |
| MR. JITENDRA NANDLALBHAI SIDDHPURA, PERFECT KITCHEN EQUIPMENT, PLOT NO. 177/1, M ROAD, AJI G.I.D.C., RAJKOT-360003, GUJARAT, INDIA. | | |
| DATE OF REGISTRATION | 17/02/2020 | |
| TITLE | DOMESTIC FLOUR MILL | |
| PRIORITY NA | | |

| | | |
|--|-------------|---|
| DESIGN NUMBER | 327292-001 |  |
| CLASS | 12-11 | |
| M/S. KAY EM KAY INDUSTRIES, H-13, TEXTILE COLONY, INDUSTRIAL AREA A, NEAR MOHAN DAI CANCER HOSPITAL, LUDHIANA - 141003, (PUNJAB), INDIA, WHOSE PARTNERS ARE 1. VIKAS GOYAL 2. SUDESH GOYAL & 3. SMT. AANCHAL GOYAL. | | |
| DATE OF REGISTRATION | 18/02/2020 | |
| TITLE | BICYCLE RIM | |
| PRIORITY NA | | |

| | | |
|---|------------|---|
| DESIGN NUMBER | 327308-001 |  |
| CLASS | 23-04 | |
| S S ENTERPRISES, FLAT NO 603, BUILDING 03, NAVRATAN HOUSING SOCIETY, 9TH ROAD, JAKU CLUB, OPP. BHOOMI TOWER, SANTACRUZ- (EAST), MUMBAI-400055 INDIA, WHOSE PROPRIETOR IS ASHOK DINGWA. | | |
| DATE OF REGISTRATION | 18/02/2020 | |
| TITLE | TOWER FAN | |
| PRIORITY NA | | |

| | |
|--|-------------|
| DESIGN NUMBER | 327344-001 |
| CLASS | 16-01 |
| SERVICE LEE TECHNOLOGIES PRIVATE LIMITED, 1022, SOLITAIRE CORPORATE PARK, BLDG 10, 2ND FLOOR, GURU HARGOVINDJI ROAD, ANDHERI EAST, MUMBAI-400093, MAHARASHTRA, INDIA. | |
| DATE OF REGISTRATION | 19/02/2020 |
| TITLE | PHOTO BOOTH |
| PRIORITY NA | |

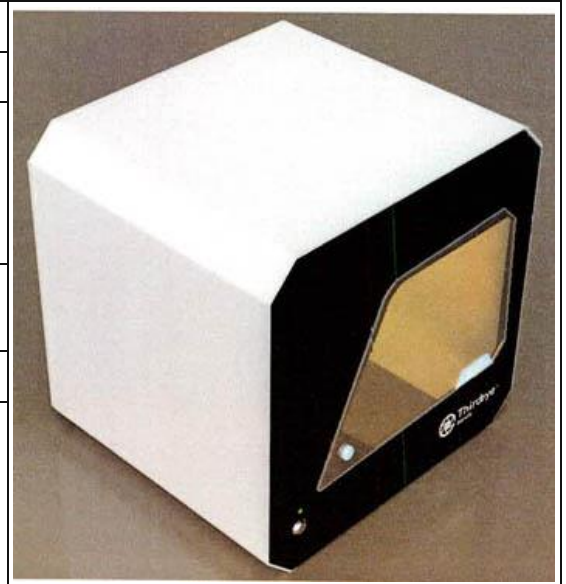

| | | |
|---|-------------------------------|-------------------|
| DESIGN NUMBER | 327401-003 | |
| CLASS | 14-99 | |
| SAMSUNG ELECTRONICS CO., LTD., 129, SAMSUNG-RO, YEONGTONG-GU, SUWON-SI, GYEONGGI-DO, REPUBLIC OF KOREA | | |
| DATE OF REGISTRATION | 20/02/2020 | |
| TITLE | STAND FOR TELEVISION RECEIVER | |
| PRIORITY | | |
| PRIORITY NUMBER | DATE | COUNTRY |
| 30-2019-0041770 | 30/08/2019 | REPUBLIC OF KOREA |

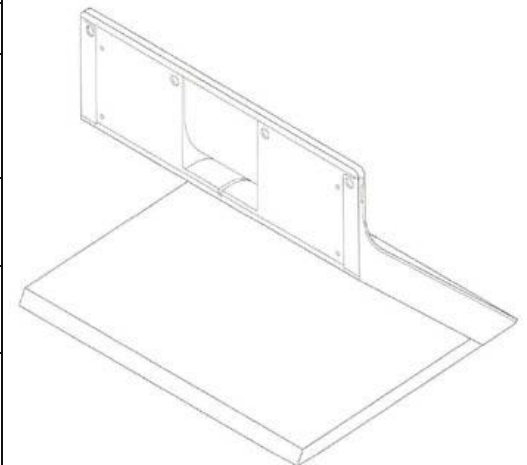

| | | |
|--|----------------|--|
| DESIGN NUMBER | 327421-003 | |
| CLASS | 12-11 | |
| JOGINDER SINGH TEJVINDER SINGH, STATION ROAD, OPP. DHANDARI RAILWAY STATION, LUDHIANA, PUNJAB, INDIA. | | |
| DATE OF REGISTRATION | 21/02/2020 | |
| TITLE | SEAT FOR CYCLE | |
| PRIORITY NA | | |



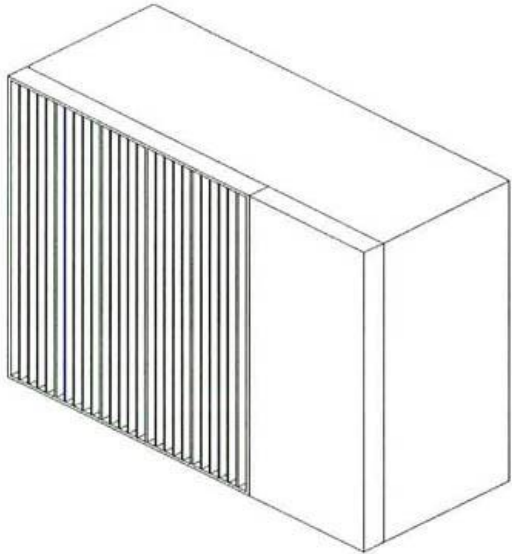

| | | |
|--|------------|--|
| DESIGN NUMBER | 327440-001 |  |
| CLASS | 02-04 | |
| M&B FOOTWEAR PVT. LTD., C-33, SECTOR 58, NOIDA-201301, U.P., INDIA. | | |
| DATE OF REGISTRATION | 21/02/2020 | |
| TITLE | INSOLE | |
| PRIORITY NA | | |

| | | | |
|--|----------------------------------|----------------|--|
| DESIGN NUMBER | 327488-001 | |  |
| CLASS | 23-04 | | |
| 1. DAIKIN INDUSTRIES, LTD., UMEDA CENTER BUILDING, 4-12 NAKAZAKI-NISHI 2-CHOME, KITA-KU, OSAKA-SHI, OSAKA-FU, JAPAN. 2. DAIKIN EUROPE N.V., ZANDVOORDESTRAAT 300, 8400 OOSTENDE, BELGIUM. | | | |
| DATE OF REGISTRATION | 24/02/2020 | | |
| TITLE | OUTDOOR UNIT FOR AIR CONDITIONER | | |
| PRIORITY | | | |
| PRIORITY NUMBER | DATE | COUNTRY | |
| 006763645-0009 | 26/08/2019 | EUIPO | |

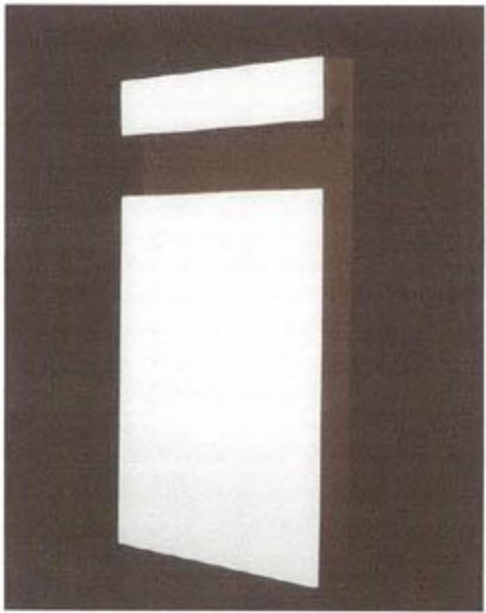
| | | | |
|--|--------------|----------------|--|
| DESIGN NUMBER | 306328 | |  |
| CLASS | 04-01 | | |
| 3M INNOVATIVE PROPERTIES COMPANY, 3M CENTER, SAINT PAUL, MINNESOTA 55133-3427, USA. | | | |
| DATE OF REGISTRATION | 06/06/2018 | | |
| TITLE | SCOURING PAD | | |
| PRIORITY | | | |
| PRIORITY NUMBER | DATE | COUNTRY | |
| 29/628,734 | 07/12/2017 | U.S.A. | |

| | | |
|---|---------------------|---|
| DESIGN NUMBER | 326979-001 |  |
| CLASS | 08-09 | |
| KITCHEN ORGANISER, SHOP NO. 1898, GROUND FLOOR, BABUWADI, NEXT TO SMG VIDYALAYA, LALIT KATA, KALYANSHIL ROAD, DOMBIVLI (E)-421203, INDIA | | |
| DATE OF REGISTRATION | 10/02/2020 | |
| TITLE | MOUNTINGS FOR DOORS | |
| PRIORITY NA | | |

| | | |
|---|-----------------------|--|
| DESIGN NUMBER | 326989-001 |  |
| CLASS | 12-16 | |
| HERO MOTOCORP LIMITED, THE GRAND PLAZA, PLOT NO.2, NELSON MANDELA ROAD, VASANT KUNJ- PHASE -II, NEW DELHI, INDIA, 110070 | | |
| DATE OF REGISTRATION | 10/02/2020 | |
| TITLE | FRONT COWL OF VEHICLE | |
| PRIORITY NA | | |



| | | |
|---|---------------------------|---|
| DESIGN NUMBER | 326992-001 |  |
| CLASS | 26-06 | |
| HERO MOTOCORP LIMITED, THE GRAND PLAZA, PLOT NO.2, NELSON MANDELA ROAD, VASANT KUNJ- PHASE -II, NEW DELHI, INDIA, 110070 | | |
| DATE OF REGISTRATION | 10/02/2020 | |
| TITLE | HEADLIGHT UNIT OF VEHICLE | |
| PRIORITY NA | | |

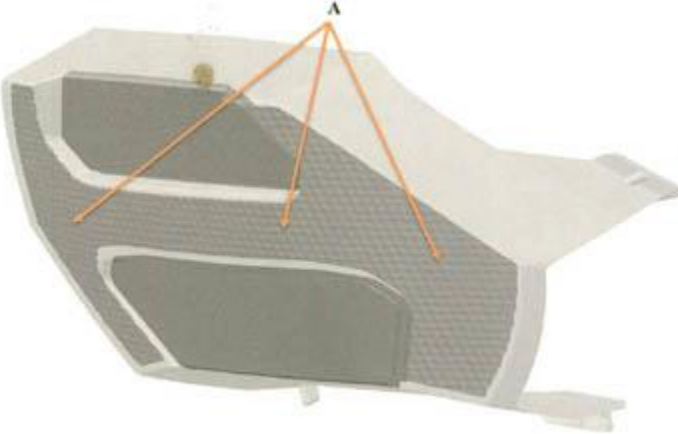

| | | |
|--|----------------------|--|
| DESIGN NUMBER | 326994-001 |  |
| CLASS | 12-16 | |
| HERO MOTOCORP LIMITED, THE GRAND PLAZA, PLOT NO.2, NELSON MANDELA ROAD, VASANT KUNJ- PHASE -II, NEW DELHI, INDIA, 110070. | | |
| DATE OF REGISTRATION | 10/02/2020 | |
| TITLE | REAR COWL OF VEHICLE | |
| PRIORITY NA | | |



| | | |
|--|------------|--|
| DESIGN NUMBER | 326999-001 |  |
| CLASS | 12-16 | |
| HERO MOTOCORP LIMITED, THE GRAND PLAZA, PLOT NO.2, NELSON MANDELA ROAD, VASANT KUNJ- PHASE -II, NEW DELHI, INDIA, 110070. | | |
| DATE OF REGISTRATION | 10/02/2020 | |
| TITLE | WHEEL | |
| PRIORITY NA | | |

| | | |
|---|----------------------------|--|
| DESIGN NUMBER | 327006-001 |  |
| CLASS | 26-06 | |
| HERO MOTOCORP LIMITED, THE GRAND PLAZA, PLOT NO.2, NELSON MANDELA ROAD, VASANT KUNJ- PHASE -II, NEW DELHI, INDIA, 110070 | | |
| DATE OF REGISTRATION | 10/02/2020 | |
| TITLE | TAIL LIGHT LENS OF VEHICLE | |
| PRIORITY NA | | |

| | | |
|---|----------------------|--|
| DESIGN NUMBER | 327009-001 |  |
| CLASS | 12-16 | |
| HERO MOTOCORP LIMITED, THE GRAND PLAZA, PLOT NO.2, NELSON MANDELA ROAD, VASANT KUNJ- PHASE -II, NEW DELHI, INDIA, 110070 | | |
| DATE OF REGISTRATION | 10/02/2020 | |
| TITLE | REAR COWL OF VEHICLE | |
| PRIORITY NA | | |
| DESIGN NUMBER | 327019-001 |  |
| CLASS | 28-03 | |
| MOHAMMED HANIF KAPADIA, 2704, A-WING, ORCHID ENCLAVE, BELLASIS ROAD, MUMBAI CENTRAL, MUMBAI - 400008 | | |
| DATE OF REGISTRATION | 10/02/2020 | |
| TITLE | HAIR TRIMMER | |
| PRIORITY NA | | |
| DESIGN NUMBER | 327022-001 |  |
| CLASS | 28-03 | |
| MOHAMMED HANIF KAPADIA, 2704, A-WING, ORCHID ENCLAVE, BELLASIS ROAD, MUMBAI CENTRAL, MUMBAI - 400008 | | |
| DATE OF REGISTRATION | 10/02/2020 | |
| TITLE | HAIR TRIMMER | |
| PRIORITY NA | | |

| | | |
|--|------------------------------------|--|
| DESIGN NUMBER | 327038-001 |  |
| CLASS | 23-04 | |
| ORIENT ELECTRIC LIMITED, UNIT VIII, PLOT NO. 7, BHOI NAGAR, BHUBANESWAR-751012, ORISSA, INDIA. | | |
| DATE OF REGISTRATION | 11/02/2020 | |
| TITLE | CEILING FAN | |
| PRIORITY NA | | |
| DESIGN NUMBER | 327064-001 |  |
| CLASS | 05-05 | |
| PAYAL SINGHAL DESIGN HOUSE LLP, 602, RAJ KUTIR BUILDING, LINKING ROAD, KHAR WEST, MUMBAI - 400052, MAHARASHTRA, INDIA. | | |
| DATE OF REGISTRATION | 11/02/2020 | |
| TITLE | TEXTILE FABRIC | |
| PRIORITY NA | | |
| DESIGN NUMBER | 327094-001 |  |
| CLASS | 23-04 | |
| P. JAYAKUMAR, JS-IP DESIGN SOLUTIONS, PLOT NO. A- 45/2, MADURAI AUTOMOBILE CO-OPERATIVE INDUSTRIAL ESTATE LTD, KAPPALUR, MADURAI - 625 008, TAMILNADU, INDIA. | | |
| DATE OF REGISTRATION | 12/02/2020 | |
| TITLE | PORTABLE INSTANT UV WATER PURIFIER | |
| PRIORITY NA | | |

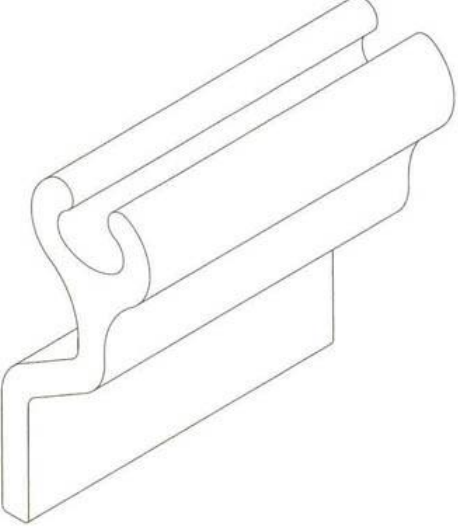
| | | | |
|---|-------------------------------|-------------------|---|
| DESIGN NUMBER | 327122-001 | |  |
| CLASS | 09-01 | | |
| EMAMI LIMITED, 701, 7TH FLOOR, A WING, EXPRESS ZONE, NEAR OBEROI MALL, GOREGAON (EAST), MUMBAI - 400 063, MAHARASHTRA, INDIA. | | | |
| DATE OF REGISTRATION | 13/02/2020 | | |
| TITLE | CONTAINER | | |
| PRIORITY NA | | | |
| DESIGN NUMBER | 327160-001 | |  |
| CLASS | 08-08 | | |
| M/S. J. K. ENTERPRISE, SHOP NO -7, HARIDHAVA MARG, KOTHARIYA MAIN ROAD, RAJKOT - 360002 GUJARAT, INDIA, WHOSE PROPRIETOR IS SHREE JIGNESHBHAI G. NASIT | | | |
| DATE OF REGISTRATION | 14/02/2020 | | |
| TITLE | WEDGES CLIP FOR TILE LEVELING | | |
| PRIORITY NA | | | |
| DESIGN NUMBER | 327189-002 | |  |
| CLASS | 14-01 | | |
| SAMSUNG ELECTRONICS CO., LTD., 129, SAMSUNG-RO, YEONGTONG-GU, SUWON-SI, GYEONGGI-DO, REPUBLIC OF KOREA | | | |
| DATE OF REGISTRATION | 14/02/2020 | | |
| TITLE | SPEAKER | | |
| PRIORITY | | | |
| PRIORITY NUMBER | DATE | COUNTRY | |
| 30-2019-0042218 | 02/09/2019 | REPUBLIC OF KOREA | |

| | | | |
|--|----------------------------|----------------|---|
| DESIGN NUMBER | 327225-001 | |  |
| CLASS | 15-99 | | |
| HODEK VIBRATION TECHNOLOGIES PVT. LTD., SAHAJPUR (NANDUR), TALUKA DOUND, DISTRICT PUNE. - 412 202 MAHARASHTRA, INDIA. | | | |
| DATE OF REGISTRATION | 14/02/2020 | | |
| TITLE | TORSIONAL VIBRATION DAMPER | | |
| PRIORITY NA | | | |
| DESIGN NUMBER | 306447 | |  |
| CLASS | 25-01 | | |
| RICHARD HEINDL, TASSILOSTR. 21, 82166 GRÄFELFING, GERMANY. | | | |
| DATE OF REGISTRATION | 08/06/2018 | | |
| TITLE | SHEET PILE CONNECTOR | | |
| PRIORITY | | | |
| PRIORITY NUMBER | DATE | COUNTRY | |
| 004540722-0010 | 08/12/2017 | EUIPO | |
| DESIGN NUMBER | 318695-001 | |  |
| CLASS | 02-04 | | |
| RELAXO FOOTWEARS LIMITED, AGGARWAL CITY SQUARE, PLOT NO. 10, MANGLAM PLACE, DISTRICT CENTRE, SECTOR – 3, ROHINI, DELHI 110085 | | | |
| DATE OF REGISTRATION | 12/06/2019 | | |
| TITLE | FOOTWEAR | | |
| PRIORITY NA | | | |