

**INTRODUCTION**

In view of the recent amendment made in the Designs (Amendment) Rules, 2008 with effect from 17/06/2008, Publication of the matter relating to Designs is being published in the Official Journal of The Patent Office. This Journal is being published on weekly basis on every Friday covering the various proceedings on Designs as required according to the provisions of under Rule 22, 25, 27 and 39 of the Design (Amendment) Rules, 2008. All the enquiries on this Official Journal and other information as required by the public should be addressed to the Controller General of Patents, Designs & Trade Marks. Suggestions and comments are requested from all quarters so that the content can be enriched.

## REGISTRATION OF DESIGNS

The following designs have been registered. They are now open for public inspection. In the following each entry the Date of Registration is shown. The Priority Number, Priority Date and Priority Country are also shown

<b>DESIGN NUMBER</b>	319514-001		
<b>CLASS</b>	24-01		
<b>ASHKAL DEVELOPMENTS LIMITED, 4TH FLOOR, EXCHANGE HOUSE, 54-58, ATHOL STREET, DOUGLAS 1 1JD, ISLE OF MAN</b>			
<b>DATE OF REGISTRATION</b>	10/07/2019		
<b>TITLE</b>	AIRWAY DEVICE		
<b>PRIORITY</b>			
<b>PRIORITY NUMBER</b>	<b>DATE</b>	<b>COUNTRY</b>	
006575411-0003	12/06/2019	EUPO	
<b>DESIGN NUMBER</b>	313833-001		
<b>CLASS</b>	28-03		
<b>FIRSTLINE, INCORPORATED, P.O. BOX 1009, STAFFORD, TEXAS 77497, U.S.A.</b>			
<b>DATE OF REGISTRATION</b>	14/01/2019		
<b>TITLE</b>	COMBINATION EDGE BRUSH		
<b>PRIORITY</b>			
<b>PRIORITY NUMBER</b>	<b>DATE</b>	<b>COUNTRY</b>	
29656467	12/07/2018	U.S.A.	
<b>DESIGN NUMBER</b>	314349-002		
<b>CLASS</b>	08-99		
<b>M/S HANUMANT POLYMERS PVT. LTD., KH. NO. 84/23/2, ROAD NO. 3, UDYOG NAGAR, INDUSTRIAL AREA, MUNDKA, DELHI - 110041, INDIA.</b>			
<b>DATE OF REGISTRATION</b>	30/01/2019		
<b>TITLE</b>	SPOOL FOR WIRE & CABLE		
<b>PRIORITY NA</b>			

<b>DESIGN NUMBER</b>	313970-001	
<b>CLASS</b>	24-01	
<b>EVAHEART, INC., 6655 TRAVIS ST., SUITE 590, HOUSTON, TEXAS 77030, UNITED STATES OF AMERICA.</b>		
<b>DATE OF REGISTRATION</b>	17/01/2019	
<b>TITLE</b>	CANNULA	
<b>PRIORITY</b>		
<b>PRIORITY NUMBER</b>	<b>DATE</b>	<b>COUNTRY</b>
29/657,632	24/07/2018	U.S.A.

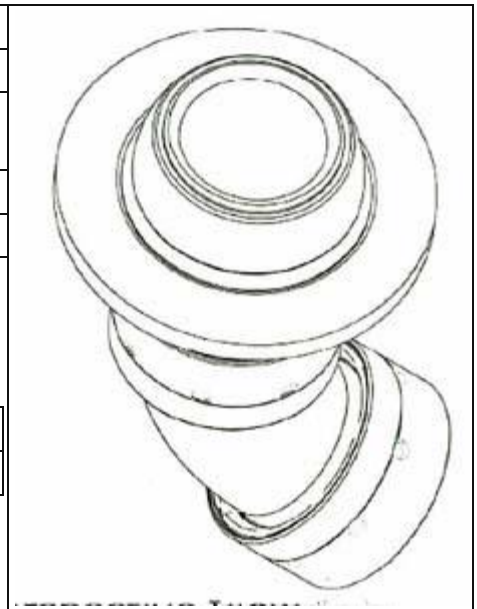

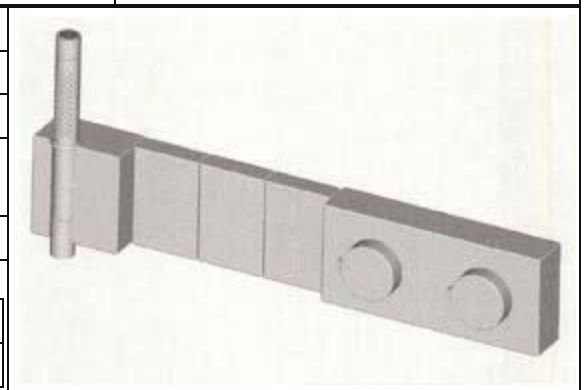

<b>DESIGN NUMBER</b>	314094-001	
<b>CLASS</b>	23-01	
<b>HANSGROHE SE, AUSTR. 5-9, 77761 SCHILTACH, GERMANY</b>		
<b>DATE OF REGISTRATION</b>	21/01/2019	
<b>TITLE</b>	FLUID DISTRIBUTION FITTING	
<b>PRIORITY</b>		
<b>PRIORITY NUMBER</b>	<b>DATE</b>	<b>COUNTRY</b>
005515749-0017	26/07/2018	EUPO

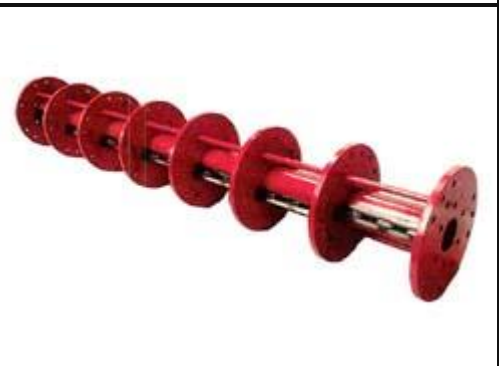

<b>DESIGN NUMBER</b>	320348-001	
<b>CLASS</b>	15-03	
<b>MAHINDRA &amp; MAHINDRA LIMITED, MAHINDRA RESEARCH VALLEY, MAHINDRA WORLD CITY, PLOT NO.41/1, ANJUR P.O., CHENGALPATTU, KANCHIPURAM DISTRICT, TAMIL NADU - 603 004, INDIA</b>		
<b>DATE OF REGISTRATION</b>	01/08/2019	
<b>TITLE</b>	MULCHER ROTOR SHAFT	
<b>PRIORITY NA</b>		



<b>DESIGN NUMBER</b>	312914-001	
<b>CLASS</b>	05-05	
<b>KAPIL A. SHOREWALA, 45/47, MIRZA STREET, ZAVERI BAZAR, 1ST FLOOR, MUMBAI-400003, MAHARASHTRA.</b>		
<b>DATE OF REGISTRATION</b>	07/12/2018	
<b>TITLE</b>	TEXTILE FABRIC	
<b>PRIORITY NA</b>		
<b>DESIGN NUMBER</b>	316840-001	
<b>CLASS</b>	02-04	
<b>WILDCRAFT INDIA PVT. LTD., 15TH CROSS ROAD, OUTER RING ROAD, J.P. NAGAR 4TH PHASE BANGALORE – 560078.</b>		
<b>DATE OF REGISTRATION</b>	14/04/2019	
<b>TITLE</b>	SOLE FOR FOOTWEAR(SET)	
<b>PRIORITY NA</b>		
<b>DESIGN NUMBER</b>	316881-001	
<b>CLASS</b>	23-04	
<b>ORIENT ELECTRIC LIMITED, UNIT VIII, PLOT NO. 7, BHOI NAGAR, BHUBANESWAR – 751012, ORISSA, INDIA.</b>		
<b>DATE OF REGISTRATION</b>	15/04/2019	
<b>TITLE</b>	CEILING FAN	
<b>PRIORITY NA</b>		

<b>DESIGN NUMBER</b>	316905-001
<b>CLASS</b>	10-06
<b>HAVELLS INDIA LIMITED, 904, 9TH FLOOR, SURYA KIRAN BUILDING, K G MARG, CONNAUGHT PLACE, NEW DELHI – 110001.</b>	
<b>DATE OF REGISTRATION</b>	16/04/2019
<b>TITLE</b>	DOORBELL
<b>PRIORITY NA</b>	









<b>DESIGN NUMBER</b>	316925-001		
<b>CLASS</b>	23-01		
<b>WATERTEC (MALAYSIA) SDN BHD, LOT 3, JALAN HALBA SATU 16/16A, SECTION 16, 40200 SHAH ALAM, SELANGOR DARUL EHSAN, MALAYSIA.</b>			
<b>DATE OF REGISTRATION</b>	16/04/2019		
<b>TITLE</b>	SINK SPOUT		
<b>PRIORITY</b>			
<b>PRIORITY NUMBER</b>	<b>DATE</b>	<b>COUNTRY</b>	
18-01077-0101	22/10/2018	MALAYSIA	



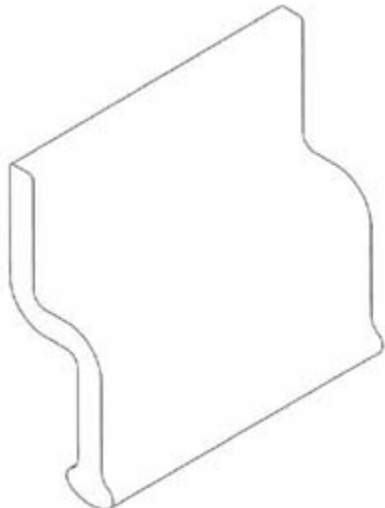

<b>DESIGN NUMBER</b>	316928-003		
<b>CLASS</b>	09-03		
<b>RECKITT BENCKISER HEALTH LIMITED, 103-105 BATH ROAD, SLOUGH, BERKSHIRE SL1 3UH, UNITED KINGDOM.</b>			
<b>DATE OF REGISTRATION</b>	16/04/2019		
<b>TITLE</b>	BOX [PACKAGING]		
<b>PRIORITY</b>			
<b>PRIORITY NUMBER</b>	<b>DATE</b>	<b>COUNTRY</b>	
005800307-0003	17/10/2018	EUIPO	



<b>DESIGN NUMBER</b>	307012		
<b>CLASS</b>	25-02		
<b>KRISHNA ARCHITECTURAL PRODUCTS, NEHRUNAGAR PRIVATE, STREET NO. 5, NR. SWATI SCHOOL, NANA MAVVA 150 FIT RING ROAD, RAJKOT, GUJARAT, INDIA, PROPRIETOR IS SAVAN JAYANTILAL UCHHADIYA.</b>			
<b>DATE OF REGISTRATION</b>	22/06/2018		
<b>TITLE</b>	PRE-ASSEMBLE FRAME		
<b>PRIORITY NA</b>			
<b>DESIGN NUMBER</b>	320095-003		
<b>CLASS</b>	07-99		
<b>NAYASA SUPERPLAST, SURVEY NO. 370/2 (7) KACHIGAM, NANI DAMAN, DAMAN – 396 210, (UNION TERRITORIES), INDIA, WHOSE PARTNERS ARE SACHIN SACHDEV &amp; MANASI SACHDEV</b>			
<b>DATE OF REGISTRATION</b>	29/07/2019		
<b>TITLE</b>	ROMANO SQUARE TRAY		
<b>PRIORITY NA</b>			
<b>DESIGN NUMBER</b>	306448		
<b>CLASS</b>	25-01		
<b>RICHARD HEINDL, TASSILOSTR. 21, 82166 GRÄFELFING, GERMANY.</b>			
<b>DATE OF REGISTRATION</b>	08/06/2018		
<b>TITLE</b>	CONNECTING ELEMENT FOR SHEET PILES		
<b>PRIORITY</b>			
<b>PRIORITY NUMBER</b>	<b>DATE</b>	<b>COUNTRY</b>	
004540722-0011	08/12/2017	EUIPO	



<b>DESIGN NUMBER</b>	316318-001	
<b>CLASS</b>	02-02	
<b>MANJUBAA CLOTHING, 29, SHANTI NAGAR SOCIETY NR SHUBHASH NAGAR, SARTHANA, SURAT-395006, GUJARAT.</b>		
<b>DATE OF REGISTRATION</b>	01/04/2019	
<b>TITLE</b>	SAREE AND BLOUSE(SET)	
<b>PRIORITY NA</b>		
<b>DESIGN NUMBER</b>	316326-001	
<b>CLASS</b>	02-02	
<b>SABYASACHI COUTURE, 86C, JATIN DAS ROAD, KOLKATA- 700029, STATE OF WEST BENGAL, WHOSE PARTNERS ARE MR. SUKUMAR MUKHERJEE AND MR. SABYASACHI MUKHERJEE.</b>		
<b>DATE OF REGISTRATION</b>	01/04/2019	
<b>TITLE</b>	LADIES GARMENT	
<b>PRIORITY NA</b>		
<b>DESIGN NUMBER</b>	316345-001	
<b>CLASS</b>	02-02	
<b>SABYASACHI COUTURE, 86C, JATIN DAS ROAD, KOLKATA- 700029, STATE OF WEST BENGAL, WHOSE PARTNERS ARE MR. SUKUMAR MUKHERJEE AND MR. SABYASACHI MUKHERJEE.</b>		
<b>DATE OF REGISTRATION</b>	01/04/2019	
<b>TITLE</b>	LADIES GARMENT	
<b>PRIORITY NA</b>		



<b>DESIGN NUMBER</b>	324538-001	
<b>CLASS</b>	26-03	
<b>HAVELLS INDIA LIMITED, 904, 9TH FLOOR, SURYA KIRAN BUILDING, K G MARG, CONNAUGHT PLACE, NEW DELHI – 110001.</b>		
<b>DATE OF REGISTRATION</b>	10/12/2019	
<b>TITLE</b>	STREET LIGHT	
<b>PRIORITY NA</b>		



<b>DESIGN NUMBER</b>	318961-001	
<b>CLASS</b>	12-11	
<b>HONDA MOTOR CO., LTD. 1-1, MINAMI-AOYAMA 2-CHOME, MINATO-KU, TOKYO, 107-8556 JAPAN</b>		
<b>DATE OF REGISTRATION</b>	21/06/2019	
<b>TITLE</b>	FRONT SIDE COWL FOR A MOTORCYCLE	
<b>PRIORITY</b>		
<b>PRIORITY NUMBER</b>	<b>DATE</b>	<b>COUNTRY</b>
2018-028654	27/12/2018	JAPAN

<b>DESIGN NUMBER</b>	317330-001	
<b>CLASS</b>	23-04	
<b>CHAIRMAN, DEFENCE RESEARCH &amp; DEVELOPMENT ORGANISATION, MINISTRY OF DEFENCE, GOVERNMENT OF INDIA, ROOM NO. 348, B-WING, DRDO BHAWAN, RAJAJI MARG, NEW DELHI-110105, INDIA.</b>		
<b>DATE OF REGISTRATION</b>	29/04/2019	
<b>TITLE</b>	AIR STERILIZATION UNIT	
<b>PRIORITY NA</b>		

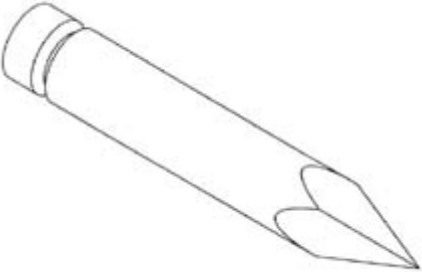

<b>DESIGN NUMBER</b>	317073-001	
<b>CLASS</b>	11-05	
<b>HIREN PRATAP SHAH, YES CREATION SHOP NO 7, JAI SAKET SOCIETY, OPP VIJAYA BHAVAN, RAIPADA, MALAD (WEST), MUMBAI-400064.</b>		
<b>DATE OF REGISTRATION</b>	23/04/2019	
<b>TITLE</b>	FESTIVE DECORATIVE ARTICLE	
<b>PRIORITY NA</b>		
<b>DESIGN NUMBER</b>	317202-001	
<b>CLASS</b>	07-06	
<b>SKYRA PROFESSIONAL EQUIPMENT PVT. LTD., KH. 312, BEHIND KANISHKA FARM, GADAIPUR MANDIGAON ROAD, SULTANPUR, NEW DELHI, DELHI 110030</b>		
<b>DATE OF REGISTRATION</b>	26/04/2019	
<b>TITLE</b>	DISH STAND	
<b>PRIORITY NA</b>		
<b>DESIGN NUMBER</b>	317606-001	
<b>CLASS</b>	02-04	
<b>RELAXO FOOTWEARS LIMITED, AGGARWAL CITY SQUARE, PLOT NO. 10, MANGLAM PLACE, DISTRICT CENTRE, SECTOR - 3, ROHINI, DELHI 110085</b>		
<b>DATE OF REGISTRATION</b>	09/05/2019	
<b>TITLE</b>	FOOTWEAR	
<b>PRIORITY NA</b>		

<b>DESIGN NUMBER</b>	316441-001	
<b>CLASS</b>	02-02	
<b>SABYASACHI COUTURE, 86C, JATIN DAS ROAD, KOLKATA- 700029, STATE OF WEST BENGAL, WHOSE PARTNERS ARE MR. SUKUMAR MUKHERJEE AND MR. SABYASACHI MUKHERJEE.</b>		
<b>DATE OF REGISTRATION</b>	04/04/2019	
<b>TITLE</b>	LADIES GARMENT	
<b>PRIORITY NA</b>		
<b>DESIGN NUMBER</b>	316488-001	
<b>CLASS</b>	24-04	
<b>BERRY GLOBAL, INC., 101 OAKLEY STREET, EVANSVILLE, INDIANA, 47710, UNITED STATES OF AMERICA.</b>		
<b>DATE OF REGISTRATION</b>	05/04/2019	
<b>TITLE</b>	PIERCING PIN FOR INHALERS	
<b>PRIORITY NA</b>		
<b>DESIGN NUMBER</b>	316531-001	
<b>CLASS</b>	02-02	
<b>SABYASACHI COUTURE, 86C, JATIN DAS ROAD, KOLKATA- 700029, STATE OF WEST BENGAL, WHOSE PARTNERS ARE MR. SUKUMAR MUKHERJEE AND MR. SABYASACHI MUKHERJEE.</b>		
<b>DATE OF REGISTRATION</b>	06/04/2019	
<b>TITLE</b>	GARMENT	
<b>PRIORITY NA</b>		

<b>DESIGN NUMBER</b>	316547-001	
<b>CLASS</b>	02-02	
<b>SABYASACHI COUTURE, 86C, JATIN DAS ROAD, KOLKATA- 700029, STATE OF WEST BENGAL, WHOSE PARTNERS ARE MR. SUKUMAR MUKHERJEE AND MR. SABYASACHI MUKHERJEE.</b>		
<b>DATE OF REGISTRATION</b>	06/04/2019	
<b>TITLE</b>	GARMENT	
<b>PRIORITY NA</b>		
<b>DESIGN NUMBER</b>	316575-001	
<b>CLASS</b>	02-02	
<b>SABYASACHI COUTURE, 86C, JATIN DAS ROAD, KOLKATA- 700029, STATE OF WEST BENGAL, WHOSE PARTNERS ARE MR. SUKUMAR MUKHERJEE AND MR. SABYASACHI MUKHERJEE.</b>		
<b>DATE OF REGISTRATION</b>	08/04/2019	
<b>TITLE</b>	LADIES GARMENT (SET)	
<b>PRIORITY NA</b>		
<b>DESIGN NUMBER</b>	316663-001	
<b>CLASS</b>	31-00	
<b>APEX CONSUMER APPLIANCES PVT. LTD., PLOT NO. 29-P, OFF KANJUR VILLAGE ROAD, OPP. CRESCENT INDUSTRIAL ESATE, KANJUR MARG (EAST), MUMBAI - 400042, INDIA.</b>		
<b>DATE OF REGISTRATION</b>	10/04/2019	
<b>TITLE</b>	MIXER GRINDER	
<b>PRIORITY NA</b>		

<b>DESIGN NUMBER</b>	316664-003
<b>CLASS</b>	23-02
<b>HSIL LIMITED, 2 RED CROSS, KOLKATA - 700001, WEST BENGAL, INDIA.</b>	
<b>DATE OF REGISTRATION</b>	11/04/2019
<b>TITLE</b>	WATER CLOSET WITH CISTERN
<b>PRIORITY NA</b>	



<b>DESIGN NUMBER</b>	327261-001	
<b>CLASS</b>	15-04	
<b>CATERPILLAR INC., 100 NE ADAMS STREET, PEORIA, ILLINOIS, 61629-9510, U.S.A.</b>		
<b>DATE OF REGISTRATION</b>	17/02/2020	
<b>TITLE</b>	BUCKET SHROUD	
<b>PRIORITY</b>		
<b>PRIORITY NUMBER</b>	<b>DATE</b>	<b>COUNTRY</b>
29/708,299	04/10/2019	U.S.A.



<b>DESIGN NUMBER</b>	327343-001	
<b>CLASS</b>	14-02	
<b>SAMSUNG ELECTRONICS CO., LTD., 129, SAMSUNG-RO, YEONGTONG-GU, SUWON-SI, GYEONGGI-DO, REPUBLIC OF KOREA</b>		
<b>DATE OF REGISTRATION</b>	19/02/2020	
<b>TITLE</b>	MONITOR	
<b>PRIORITY</b>		
<b>PRIORITY NUMBER</b>	<b>DATE</b>	<b>COUNTRY</b>
30-2019-0041664	30/08/2019	REPUBLIC OF KOREA

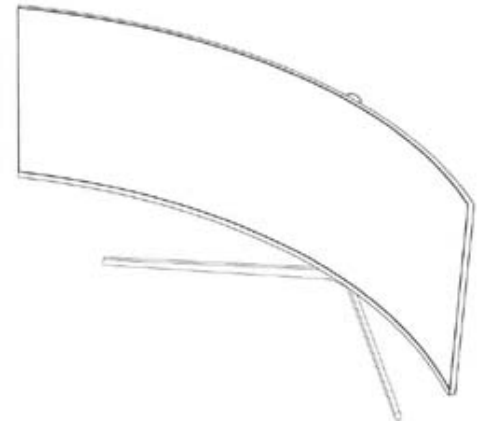

<b>DESIGN NUMBER</b>	327349-001
<b>CLASS</b>	21-01
<b>PLAYGRO TOYS INDIA PVT. LTD., 2057/38, GOLD PLAZA BUILDING, GURUDWARA ROAD, KAROL BAGH, NEW DELHI-110005., INDIA.</b>	
<b>DATE OF REGISTRATION</b>	19/02/2020
<b>TITLE</b>	AEROPLANE RIDE TOY
<b>PRIORITY NA</b>	



<b>DESIGN NUMBER</b>	327401-002	
<b>CLASS</b>	14-03	
<b>SAMSUNG ELECTRONICS CO., LTD., 129, SAMSUNG-RO, YEONGTONG-GU, SUWON-SI, GYEONGGI-DO, REPUBLIC OF KOREA</b>		
<b>DATE OF REGISTRATION</b>	20/02/2020	
<b>TITLE</b>	TELEVISION RECEIVER	
<b>PRIORITY</b>		
<b>PRIORITY NUMBER</b>	<b>DATE</b>	<b>COUNTRY</b>
30-2019-0042405	03/09/2019	REPUBLIC OF KOREA

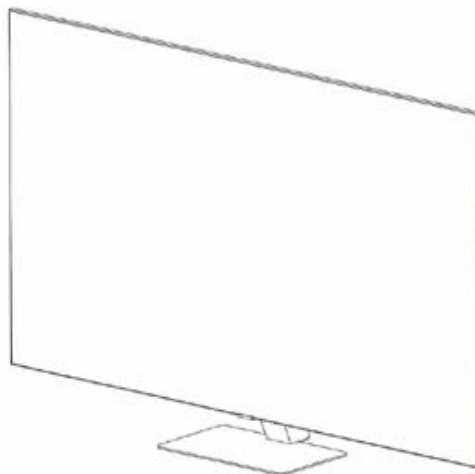



<b>DESIGN NUMBER</b>	327511-001	
<b>CLASS</b>	15-99	
<b>SIKANDARBHAI O. BAMBHANIYA, M/S. EKTA INDUSTRIES, 80 FEET ROAD, AJI VASAHA, STREET NO. 9, NEAR VINAYAK INDUSTRIES, AJAY WEIGH BRIDGE, RAJKOT - 360003, GUJARAT - INDIA.</b>		
<b>DATE OF REGISTRATION</b>	25/02/2020	
<b>TITLE</b>	NAIL MAKING MACHINE	
<b>PRIORITY NA</b>		





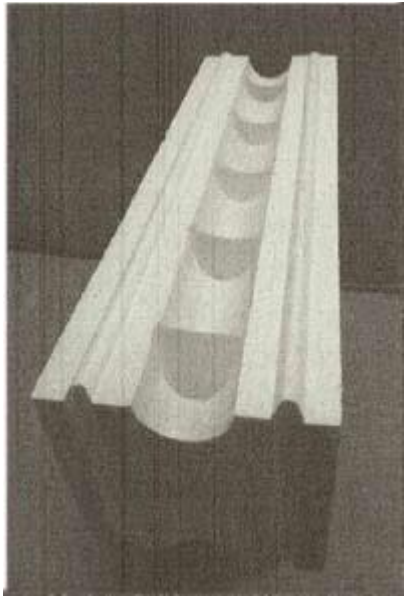

<b>DESIGN NUMBER</b>	326737-001	
<b>CLASS</b>	30-03	
<b>NEERAJ JAIN, C-37/1, WAZIRPUR INDUSTRIAL AREA DELHI-110052.</b>		
<b>DATE OF REGISTRATION</b>	03/02/2020	
<b>TITLE</b>	PET FEEDING CONTAINER	
<b>PRIORITY NA</b>		
<b>DESIGN NUMBER</b>	326768-001	
<b>CLASS</b>	03-03	
<b>TYNOR ORTHOTICS PVT. LTD., PLOT NO- 169-170, SECTOR-82, JLPL INDUSTRIAL AREA, MOHALI, PUNJAB, INDIA.</b>		
<b>DATE OF REGISTRATION</b>	04/02/2020	
<b>TITLE</b>	BASE FOR WALKING STICKS	
<b>PRIORITY NA</b>		
<b>DESIGN NUMBER</b>	326910-001	
<b>CLASS</b>	26-02	
<b>ARROW ELECTRICALS, C/O. CHOICE ELECTRICALS, STATION ROAD PO. BOX NO. 41, PALANPUR - 385001, GUJARAT - INDIA, WHOSE PARTNERS ARE (1) ABDUL HAQ AMINBHAI MACHHALIYA (2) AYUB BHAI AMINBHAI MACHHALIYA AND (3) ASLAM BHAI AMINBHAI MACHHALIYA</b>		
<b>DATE OF REGISTRATION</b>	07/02/2020	
<b>TITLE</b>	TORCH	
<b>PRIORITY NA</b>		

<b>DESIGN NUMBER</b>	319224-001	
<b>CLASS</b>	19-02	
<b>DR. C.V. RAMAN UNIVERSITY, KARGI ROAD, KOTA BILASPUR (C.G)- 495113.</b>		
<b>DATE OF REGISTRATION</b>	30/06/2019	
<b>TITLE</b>	PUNCHING MACHINE FOR PAPER	
<b>PRIORITY NA</b>		
<b>DESIGN NUMBER</b>	319248-001	
<b>CLASS</b>	07-02	
<b>M/S KAFF APPLIANCES INDIA PVT. LTD, S.S. PLAZA, 4TH FLOOR, SECTOR-47, GURUGRAM, HARYANA-122018.</b>		
<b>DATE OF REGISTRATION</b>	28/06/2019	
<b>TITLE</b>	GAS STOVE KNOB	
<b>PRIORITY NA</b>		
<b>DESIGN NUMBER</b>	319300-001	
<b>CLASS</b>	06-05	
<b>FEATHERLITE OFFICE SYSTEMS (P) LTD, NO.16/A, MILLERS TANK BUND ROAD, BEHIND AMBEDKAR BHAWAN, VASANTHNAGAR, BANGALORE – 560052, KARNATAKA, INDIA</b>		
<b>DATE OF REGISTRATION</b>	03/07/2019	
<b>TITLE</b>	FURNITURE SET	
<b>PRIORITY NA</b>		

<b>DESIGN NUMBER</b>	326943-001	
<b>CLASS</b>	25-01	
<b>SUBHASH CHANDRA SIBAL, 33/8 GROUND FLOOR, WEST PATEL NAGAR, NEW DELHI – 110008, INDIA</b>		
<b>DATE OF REGISTRATION</b>	10/02/2020	
<b>TITLE</b>	BUILDING BLOCK	
<b>PRIORITY NA</b>		
<b>DESIGN NUMBER</b>	326945-010	
<b>CLASS</b>	05-05	
<b>SIDDHI VINAYAK KNOTS AND PRINTS PVT. LTD., A- 26 CENTRAL PARK, GIDC PANDESARA, SURAT, GUJARAT - 394221</b>		
<b>DATE OF REGISTRATION</b>	10/02/2020	
<b>TITLE</b>	TEXTILE FABRIC	
<b>PRIORITY NA</b>		
<b>DESIGN NUMBER</b>	326996-001	
<b>CLASS</b>	26-06	
<b>HERO MOTOCORP LIMITED, THE GRAND PLAZA, PLOT NO.2, NELSON MANDELA ROAD, VASANT KUNJ- PHASE -II, NEW DELHI, INDIA, 110070</b>		
<b>DATE OF REGISTRATION</b>	10/02/2020	
<b>TITLE</b>	TAIL LIGHT OF VEHICLE	
<b>PRIORITY NA</b>		

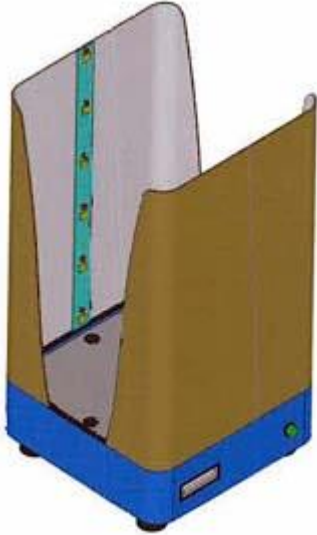

<b>DESIGN NUMBER</b>	327013-001	
<b>CLASS</b>	21-01	
<b>SONAVI DESAI, 2903-B VIVAREA, JACOB CIRCLE, MAHALAXMI, MUMBAI 400011, MAHARASHTRA, INDIA.</b>		
<b>DATE OF REGISTRATION</b>	10/02/2020	
<b>TITLE</b>	BOARD GAME	
<b>PRIORITY NA</b>		
<b>DESIGN NUMBER</b>	327041-003	
<b>CLASS</b>	05-05	
<b>SIDDHI VINAYAK KNOTS AND PRINTS PVT. LTD., A- 26 CENTRAL PARK, GIDC PANDESARA, SURAT, GUJARAT - 394221</b>		
<b>DATE OF REGISTRATION</b>	11/02/2020	
<b>TITLE</b>	TEXTILE FABRIC	
<b>PRIORITY NA</b>		
<b>DESIGN NUMBER</b>	327053-001	
<b>CLASS</b>	24-04	
<b>SUNGREEN HERBAL VISION, NO. 1703, 46TH STREET, PHASE II, SATHUVACHARI, VELLORE - 632 009, TAMIL NADU, WHOSE PARTNERS ARE S. K. SABAPATHY AND RITHA SABAPATHY.</b>		
<b>DATE OF REGISTRATION</b>	11/02/2020	
<b>TITLE</b>	INHALER AND ROLL ON	
<b>PRIORITY NA</b>		

<b>DESIGN NUMBER</b>	327063-001	
<b>CLASS</b>	05-05	
<b>PAYAL SINGHAL DESIGN HOUSE LLP, 602, RAJ KUTIR BUILDING, LINKING ROAD, KHAR WEST, MUMBAI - 400052, MAHARASHTRA, INDIA.</b>		
<b>DATE OF REGISTRATION</b>	11/02/2020	
<b>TITLE</b>	TEXTILE FABRIC	
<b>PRIORITY NA</b>		
<b>DESIGN NUMBER</b>	327094-002	
<b>CLASS</b>	23-01	
<b>P. JAYAKUMAR, JS-IP DESIGN SOLUTIONS, PLOT NO. A- 45/2, MADURAI AUTOMOBILE CO-OPERATIVE INDUSTRIAL ESTATE LTD, KAPPALUR, MADURAI - 625 008, TAMILNADU, INDIA.</b>		
<b>DATE OF REGISTRATION</b>	12/02/2020	
<b>TITLE</b>	PORTABLE INSTANT WATER BOTTLE UV WATER PURIFIER	
<b>PRIORITY NA</b>		
<b>DESIGN NUMBER</b>	327101-002	
<b>CLASS</b>	23-01	
<b>1.DURGA DAS, CEO AND CO FOUNDER, AERONERO SOLUTIONS PRIVATE LIMITED, NO 16, RANJITH ROAD, KOTTURPURAM, CHENNAI - 600085, TAMILNADU, INDIA. 2. JANESHWARA RAJA N J, HEAD - DESIGN AND DEVELOPMENT, AERONERO SOLUTIONS PRIVATE LIMITED, NO 16, RANJITH ROAD, KOTTURPURAM, CHENNAI - 600085, TAMILNADU, INDIA.</b>		
<b>DATE OF REGISTRATION</b>	12/02/2020	
<b>TITLE</b>	ATMOSPHERIC WATER GENERATOR	
<b>PRIORITY NA</b>		

<b>DESIGN NUMBER</b>	327102-001	
<b>CLASS</b>	12-11	
<b>M/S. AVON CYCLES LIMITED, G. T. ROAD, LUDHIANA - 141003, INDIA.</b>		
<b>DATE OF REGISTRATION</b>	12/02/2020	
<b>TITLE</b>	CYCLE	
<b>PRIORITY NA</b>		

<b>DESIGN NUMBER</b>	327191-002	
<b>CLASS</b>	03-01	
<b>HAMILTON HOUSEWARES PVT. LTD., KAISER-I-HIND BUILDING, 3RD FLOOR, CURRIMBHOY RD, BALLARD ESTATE, FORT, MUMBAI, MAHARASHTRA 400001, INDIA</b>		
<b>DATE OF REGISTRATION</b>	14/02/2020	
<b>TITLE</b>	SHOPPING BAG	
<b>PRIORITY NA</b>		