

## **INTRODUCTION**

**In view of the recent amendment made in the Designs (Amendment) Rules, 2008 with effect from 17/06/2008, Publication of the matter relating to Designs is being published in the Official Journal of The Patent Office. This Journal is being published on weekly basis on every Friday covering the various proceedings on Designs as required according to the provisions of under Rule 22, 25, 27 and 39 of the Design (Amendment) Rules, 2008. All the enquiries on this Official Journal and other information as required by the public should be addressed to the Controller General of Patents, Designs & Trade Marks. Suggestions and comments are requested from all quarters so that the content can be enriched.**

## **DESIGN ASSIGNMENT**

### **THE DESIGNS ACT 2000 SECTION 30**

The Design stands in the name of BURKERT WERKE GMBH & CO. KG., registered under the Designs Act, 2000 has been assigned in the Register of Design in the name as follows:-

| Design No. | Class | Name  |
|------------|-------|---|
| 204676     | 23-01 | <b>BURKERT WERKE GMBH,<br/>CHRISTIAN-BURKERT, STR.<br/>13-17, 74653, INGELFINGEN,<br/>GERMANY</b> |
| 204677     | 23-01 | <b>BURKERT WERKE GMBH,<br/>CHRISTIAN-BURKERT, STR.<br/>13-17, 74653, INGELFINGEN,<br/>GERMANY</b> |



The Design stands in the name of BUNKA SOUGO KENKYUSYO K.K., registered under the Designs Act, 2000 has been assigned in the Register of Design in the name as follows:-

| Design No. | Class | Name  |
|------------|-------|---|
| 211862     | 12-16 | <b>GALLERY ABARTH INC. OF<br/>9-5-15, AKASAKA, MINATO-<br/>KU, TOKYO, JAPAN</b> |

## REGISTRATION OF DESIGNS

The following designs have been registered. They are now open for public inspection. In the following each entry the Date of Registration is shown. The Priority Number, Priority Date and Priority Country are also shown

|   |                                |         |  |
|---|--------------------------------|---------|--|
| <b>Design Number</b>  | 215689                         |         |   |
| <b>Class</b>  | 12-16                          |         |  |
| <b>1)Honda Motor Co., Ltd.,</b><br>1-1, Minami-Aoyama 2-Chome, Minato-Ku, Tokyo, Japan. |                                |         |  |
| <b>Date of Registration</b>   | 02/04/2008                     |         |  |
| <b>Title</b>  | Front Cover For Motor Scooter  |         |  |
| <b>Priority</b>   |                                |         |  |
| Priority Number   | Date                           | Country |  |
| 2007-027094   | 04/10/2007                     | Japan   |  |
| <b>Design Number</b>  | 215690                         |         |   |
| <b>Class</b>  | 12-11                          |         |  |
| <b>1)Honda Motor Co., Ltd.,</b><br>1-1, Minami-Aoyama 2-Chome, Minato-Ku, Tokyo, Japan. |                                |         |  |
| <b>Date of Registration</b>   | 02/04/2008                     |         |  |
| <b>Title</b>  | Motor Scooter                  |         |  |
| <b>Priority</b>   |                                |         |  |
| Priority Number   | Date                           | Country |  |
| 2007-027092   | 04/10/2007                     | Japan   |  |
| <b>Design Number</b>  | 215691                         |         |  |
| <b>Class</b>  | 12-16                          |         |  |
| <b>1)Honda Motor Co., Ltd.,</b><br>1-1, Minami-Aoyama 2-Chome, Minato-Ku, Tokyo, Japan. |                                |         |  |
| <b>Date of Registration</b>   | 02/04/2008                     |         |  |
| <b>Title</b>  | Handle Cover For Motor Scooter |         |  |
| <b>Priority</b>   |                                |         |  |
| Priority Number   | Date                           | Country |  |
| 2007-027093   | 04/10/2007                     | Japan   |  |

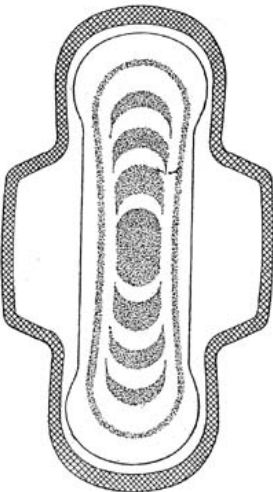
|   |                 |         |   |
|---|-----------------|---------|---|
| <b>Design Number</b>  | 218333          |         |    |
| <b>Class</b>  | 07-02           |         |   |
| <b>1)Dart Industries Inc.,</b><br>14901 South Orange Blossom Trail, Orlando, Florida 32837, USA   |                 |         |   |
| <b>Date of Registration</b>   | 01/09/2008      |         |   |
| <b>Title</b>  | Container Lid   |         |   |
| <b>Priority</b>   |                 |         |   |
| Priority Number   | Date            | Country |   |
| 29/300, 404   | 21/01/2008      | U.S.A.  |   |
| <b>Design Number</b>  | 220866          |         |   |
| <b>Class</b>  | 13-02           |         |   |
| <b>1)SU-KAM POWER SYSTEMS LTD.,</b><br>PLOT NO. WZ-1401/2, NANGAL RAYA, NEW DELHI-110 046, INDIA. |                 |         |   |
| <b>Date of Registration</b>   | 20/01/2009      |         |   |
| <b>Title</b>  | Inverter        |         |   |
| <b>Priority NA</b>  |                 |         |   |
| <b>Design Number</b>  | 220871          |         |  |
| <b>Class</b>  | 24-04           |         |   |
| <b>1)McNeil PPC, INC.,</b><br>199 Grandview Road, Skillman, Nj 08558, Usa.                        |                 |         |   |
| <b>Date of Registration</b>   | 20/01/2009      |         |   |
| <b>Title</b>  | Sanitary Napkin |         |   |
| <b>Priority</b>   |                 |         |   |
| Priority Number   | Date            | Country |   |
| 29/322182   | 30/07/2008      | U.S.A.  |   |

|   |                 |         |
|---|-----------------|---------|
| <b>Design Number</b>  | 220872          |         |
| <b>Class</b>  | 24-04           |         |
| 1)Mcneil PPC, INC.,<br>199 Grandview Road, Skillman, Nj 08558, Usa. |                 |         |
| <b>Date of Registration</b>   | 20/01/2009      |         |
| <b>Title</b>  | Sanitary Napkin |         |
| <b>Priority</b>   |                 |         |
| Priority Number   | Date            | Country |
| 29/322187   | 30/07/2008      | U.S.A.  |

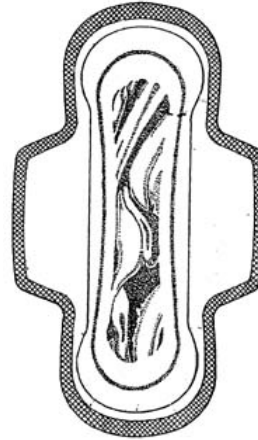



|   |                       |         |
|---|-----------------------|---------|
| <b>Design Number</b>  | 221009                |         |
| <b>Class</b>  | 07-02                 |         |
| 1)Amc International Alfa Metalcraft Corporation Ag<br>Buonaserastrasse 30 6343 Rotkreuz Switzerland., |                       |         |
| <b>Date of Registration</b>   | 30/01/2009            |         |
| <b>Title</b>  | Cover For Cooking Pot |         |
| <b>Priority</b>   |                       |         |
| Priority Number   | Date                  | Country |
| DM / 070518   | 31/07/2008            | WIPO    |





|  |                                    |  |
|--|------------------------------------|--|
| <b>Design Number</b>   | 221041                             |  |
| <b>Class</b>   | 23-02                              |  |
| 1)HSIL Limited.,<br>Bahadurgarh-124507, Dist. Jhajjar, Haryana, India. |                                    |  |
| <b>Date of Registration</b>  | 02/02/2009                         |  |
| <b>Title</b>   | Wall Mounted European Water Closet |  |
| <b>Priority NA</b>   |                                    |  |



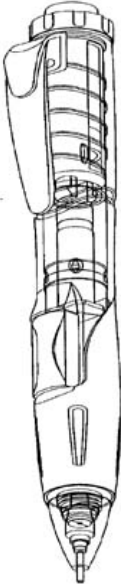

|  |               |         |   |
|--|---------------|---------|---|
| <b>Design Number</b>   | 221094        |         |    |
| <b>Class</b>   | 14-03         |         |   |
| <b>1)Nokia Corporation.,</b><br>Keilalahdentie 4, Fin-02150 Espoo, Finland.  |               |         |   |
| <b>Date of Registration</b>  | 06/02/2009    |         |   |
| <b>Title</b>   | Handset       |         |   |
| <b>Priority NA</b>   |               |         |   |
| <b>Design Number</b>   | 214844        |         |   |
| <b>Class</b>   | 09-05         |         |   |
| <b>1)Deutsche Sisi-Werke Gmbh &amp; Co. Betriebs Kg.,</b><br>Rudolf-Wild-Str. 107-115, 69214 Eppelheim, Germany.                     |               |         |   |
| <b>Date of Registration</b>  | 22/02/2008    |         |   |
| <b>Title</b>   | Drink Pouch   |         |   |
| <b>Priority</b>  |               |         |   |
| Priority Number  | Date          | Country |   |
| 29/283,776   | 23/08/2007    | U.S.A.  |   |
| <b>Design Number</b>   | 219669        |         |  |
| <b>Class</b>   | 06-13         |         |   |
| <b>1)Eicher Goodearth Private Limited</b><br>12 Commercial Complex, Greater Kailash, Part-II, (Masjid Moth), New Delhi-110048, India |               |         |   |
| <b>Date of Registration</b>  | 12/11/2008    |         |   |
| <b>Title</b>   | Cushion Cover |         |   |
| <b>Priority NA</b>   |               |         |   |

|  |                               |                |
|--|-------------------------------|----------------|
| <b>Design Number</b>   | 219670                        |                |
| <b>Class</b>   | 06-13                         |                |
| <b>1)Eicher Goodearth Private Limited</b><br>12 Commercial Complex, Greater Kailash, Part-II, (Masjid Moth), New Delhi-110048, India |                               |                |
| <b>Date of Registration</b>  | 12/11/2008                    |                |
| <b>Title</b>   | Cushion Cover                 |                |
| <b>Priority NA</b>   |                               |                |
| <b>Design Number</b>   | 219797                        |                |
| <b>Class</b>   | 08-06                         |                |
| <b>1)M/s. Nevil Enterprise</b><br>80 Feet Road, Behind K. Rasiklal, 5 Ramnagar, Rajkot-360003, Gujarat State, India                  |                               |                |
| <b>Date of Registration</b>  | 21/11/2008                    |                |
| <b>Title</b>   | Handle                        |                |
| <b>Priority NA</b>   |                               |                |
| <b>Design Number</b>   | 219816                        |                |
| <b>Class</b>   | 24-01                         |                |
| <b>1)Koninklijke Philips Electronics N.V.,</b><br>Groenewoudseweg 1, 5621 Ba Eindhoven, The Netherlands.                             |                               |                |
| <b>Date of Registration</b>  | 21/11/2008                    |                |
| <b>Title</b>   | Diagnosis Apparatus Cartridge |                |
| <b>Priority</b>  |                               |                |
| <b>Priority Number</b>   | <b>Date</b>                   | <b>Country</b> |
| 000938279-0002   | 22/05/2008                    | OHIM           |



|  |                   |                |   |
|--|-------------------|----------------|---|
| <b>Design Number</b>   | 219874            |                |    |
| <b>Class</b>   | 30-02             |                |   |
| <b>1)M/s. Ganpati Poultry Equipments</b><br>14/27B, Dr. H.K. Chatterjee Lane, Ghosuri, Howrah-711107, West Bengal, India |                   |                |   |
| <b>Date of Registration</b>  | 26/11/2008        |                |   |
| <b>Title</b>   | Cage Basin        |                |   |
| <b>Priority NA</b>   |                   |                |   |
| <b>Design Number</b>   | 219987            |                |   |
| <b>Class</b>   | 19-06             |                |   |
| <b>1)Pentel Kabushiki Kaisha</b><br>7-2, Nihonbashi Koami-Cho, Chou-Ku, Tokyo, Japan                                     |                   |                |   |
| <b>Date of Registration</b>  | 03/12/2008        |                |   |
| <b>Title</b>   | Mechanical Pencil |                |   |
| <b>Priority</b>  |                   |                |   |
| <b>Priority Number</b>   | <b>Date</b>       | <b>Country</b> |   |
| 2008-014402  | 06/06/2008        | Japan          |   |
| <b>Priority</b>  |                   |                |   |
| <b>Priority</b>  |                   |                |   |
| <b>Design Number</b>   | 220021            |                |  |
| <b>Class</b>   | 24-02             |                |   |
| <b>1)Sulzer Mixpac Ag</b><br>Grundstrasse 12, CH-6343 Rotkreuz, Switzerland  |                   |                |   |
| <b>Date of Registration</b>  | 05/12/2008        |                |   |
| <b>Title</b>   | Coupling Element  |                |   |
| <b>Priority</b>  |                   |                |   |
| <b>Priority Number</b>   | <b>Date</b>       | <b>Country</b> |   |
| 000960802  | 12/06/2008        | OHIM           |   |

|   |                   |                |   |
|---|-------------------|----------------|---|
| <b>Design Number</b>  | 223138            |                |     |
| <b>Class</b>  | 23-04             |                |   |
| <b>1)Usha International Limited</b><br>Surya Kiran Building, 19 Kasturba Gandhi marg, New Delhi -110001, India    |                   |                |   |
| <b>Date of Registration</b>   | 02/06/2009        |                |   |
| <b>Title</b>  | Fan               |                |   |
| <b>Priority NA</b>  |                   |                |   |
| <b>Design Number</b>  | 223190            |                |    |
| <b>Class</b>  | 07-04             |                |   |
| <b>1)Associated Agencies</b><br>No. 81, Nainiyappa Naicken Street, Park Town, Chennai - 600 003, Tamilnadu, India |                   |                |   |
| <b>Date of Registration</b>   | 05/06/2009        |                |   |
| <b>Title</b>  | Juice Extractor   |                |   |
| <b>Priority NA</b>  |                   |                |   |
| <b>Design Number</b>  | 223196            |                |  |
| <b>Class</b>  | 12-16             |                |   |
| <b>1)Dr. Ing. H.C.F. Porsche Aktiengesellschaft</b><br>Porscheplatz 1, 70435 Stuttgart, Germany                   |                   |                |   |
| <b>Date of Registration</b>   | 05/06/2009        |                |   |
| <b>Title</b>  | Wheel For Vehicle |                |   |
| <b>Priority</b>   |                   |                |   |
| <b>Priority Number</b>  | <b>Date</b>       | <b>Country</b> |   |
| DE-402009000033.4   | 19/12/2008        | Germany        |   |

|   |            |         |
|---|------------|---------|
| <b>Design Number</b>  | 217236     |         |
| <b>Class</b>  | 21-01      |         |
| <b>1)Ferrari S.P.A.,</b><br>Emilia Est 1163, I-41100 Modena, Italy. |            |         |
| <b>Date of Registration</b>   | 22/07/2008 |         |
| <b>Title</b>  | Toy-Car    |         |
| <b>Priority</b>   |            |         |
| Priority Number   | Date       | Country |
| 000876818   | 12/02/2008 | OHIM    |

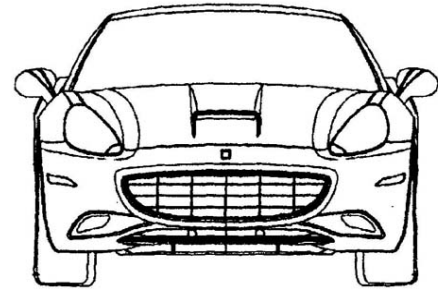

|  |                |         |
|--|----------------|---------|
| <b>Design Number</b>   | 220137         |         |
| <b>Class</b>   | 12-07          |         |
| <b>1)Icon Aircraft, Inc.,</b><br>Delaware, USA, 12511 Beatrice Street, Los Angeles, Ca 90066 |                |         |
| <b>Date of Registration</b>  | 11/12/2008     |         |
| <b>Title</b>   | Sport Aircraft |         |
| <b>Priority</b>  |                |         |
| Priority Number  | Date           | Country |
| 29/319641  | 11/06/2008     | U.S.A.  |

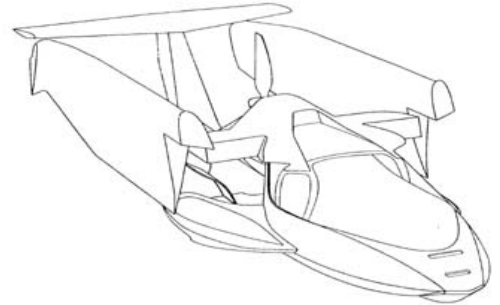

|  |                      |  |
|--|----------------------|--|
| <b>Design Number</b>   | 220185               |  |
| <b>Class</b>   | 05-06                |  |
| <b>1)Shemaroo Entertainment Pvt. Ltd.,</b><br>Shemaroo House, Plot No. 18, Marol Co-op. Industrial Estate,<br>Off Andheri-Kurla Road, Andheri (E), Mumbai-400059<br>Maharashtra, India |                      |  |
| <b>Date of Registration</b>  | 15/12/2008           |  |
| <b>Title</b>   | Foil (Self Adhesive) |  |
| <b>Priority NA</b>   |                      |  |



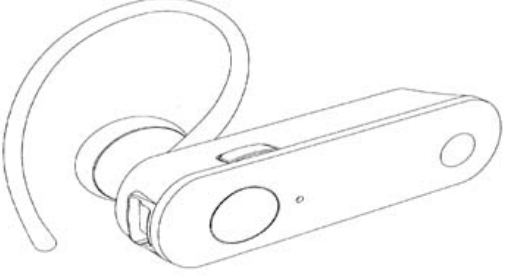

|  |                      |  |
|--|----------------------|--|
| <b>Design Number</b>   | 220191               |  |
| <b>Class</b>   | 05-06                |  |
| <b>1)Shemaroo Entertainment Pvt. Ltd.,</b><br>Shemaroo House, Plot No. 18, Marol Co-op. Industrial Estate, Off Andheri-Kurla Road, Andheri (E), Mumbai-400059 Maharashtra, India |                      |  |
| <b>Date of Registration</b>  | 15/12/2008           |  |
| <b>Title</b>   | Foil (Self Adhesive) |  |
| <b>Priority NA</b>   |                      |  |

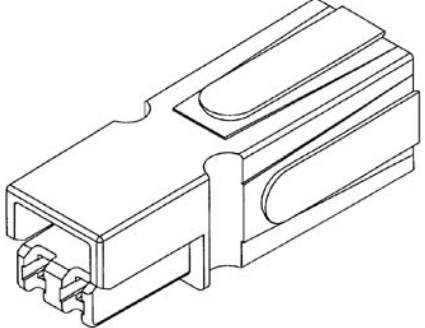
|   |                                    |         |   |
|---|------------------------------------|---------|---|
| <b>Design Number</b>  | 220277                             |         |  |
| <b>Class</b>  | 14-03                              |         |   |
| <b>1)Motorola, Inc.,</b><br>1303 East Algonquin Road, Schaumburg, Illinois-60196 United States of America |                                    |         |   |
| <b>Date of Registration</b>   | 16/12/2008                         |         |   |
| <b>Title</b>  | Headset For A Communication Device |         |   |
| <b>Priority</b>   |                                    |         |   |
| Priority Number   | Date                               | Country |   |
| 29/319, 864   | 17/06/2008                         | U.S.A.  |   |

|   |                      |         |   |
|---|----------------------|---------|---|
| <b>Design Number</b>  | 220290               |         |  |
| <b>Class</b>  | 13-03                |         |   |
| <b>1)Anderson Power Products, Inc.,</b><br>13 Prattts Junction Road, Sterling Ma 01564 United States of America |                      |         |   |
| <b>Date of Registration</b>   | 17/12/2008           |         |   |
| <b>Title</b>  | Electrical Connector |         |   |
| <b>Priority</b>   |                      |         |   |
| Priority Number   | Date                 | Country |   |
| 29/324, 296   | 10/09/2008           | U.S.A.  |   |

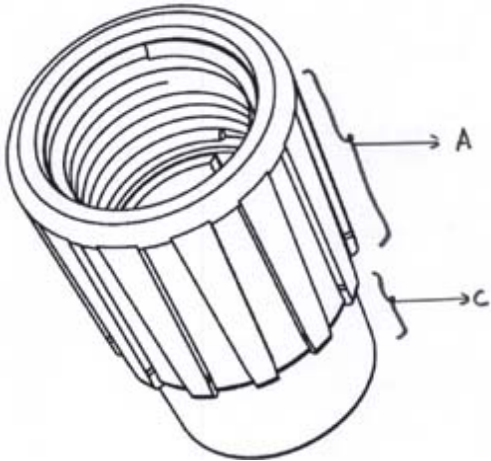
| <b>Design Number</b>  | 220314                |         |    |         |             |            |
|---|-----------------------|---------|---|---------|-------------|------------|
| <b>Class</b>  | 05-05                 |         |   |         |             |            |
| <b>1)Eicher Goodearth Private Limited</b><br>Eicher House, 12 Commercial Complex, Greater Kailash-Part II (Masjid Moth), New Delhi-110048, India  |                       |         |   |         |             |            |
| <b>Date of Registration</b>   | 18/12/2008            |         |   |         |             |            |
| <b>Title</b>  | Textile Fabric        |         |   |         |             |            |
| <b>Priority NA</b>  |                       |         |   |         |             |            |
| <b>Design Number</b>  | 220430                |         |   |         |             |            |
| <b>Class</b>  | 13-03                 |         |   |         |             |            |
| <b>1)Smk Co., Ltd.,</b><br>830-5, Ooi, Tsukui-cho, Sagamihara-shi, Kanagawa, Japan  |                       |         |   |         |             |            |
| <b>Date of Registration</b>   | 23/12/2008            |         |   |         |             |            |
| <b>Title</b>  | Electrode For Welding |         |   |         |             |            |
| <b>Priority</b>   |                       |         |   |         |             |            |
| <table border="1"> <thead> <tr> <th>Priority Number</th> <th>Date</th> <th>Country</th> </tr> </thead> <tbody> <tr> <td>2008-016106</td> <td>24/06/2008</td> <td>Japan</td> </tr> </tbody> </table> | Priority Number       | Date    |   | Country | 2008-016106 | 24/06/2008 |
| Priority Number   | Date                  | Country |   |         |             |            |
| 2008-016106   | 24/06/2008            | Japan   |   |         |             |            |
| <b>Design Number</b>  | 220478                |         |  |         |             |            |
| <b>Class</b>  | 29-02                 |         |   |         |             |            |
| <b>1)Life Line Security &amp; System</b><br>20, Farishta Complex, Ge Rd, Raipur-Pin 492001, Chhattisgarh, India   |                       |         |   |         |             |            |
| <b>Date of Registration</b>   | 24/12/2008            |         |   |         |             |            |
| <b>Title</b>  | Mobile Shield         |         |   |         |             |            |
| <b>Priority NA</b>  |                       |         |   |         |             |            |

|   |   |                |   |
|---|---|----------------|---|
| <b>Design Number</b>  | 222514                                    |                |     |
| <b>Class</b>  | 15-05                                     |                |   |
| <b>1)Geeli Machinery Works</b><br>Plot No-3A, Mona Estate, Opp. Anil Starch Mill, Anil Road, Ahmedabad-380025, Gujarat, India |   |                |   |
| <b>Date of Registration</b>   | 20/04/2009                                |                |   |
| <b>Title</b>  | Dewatering Machine                        |                |   |
| <b>Priority NA</b>  |   |                |   |
| <b>Design Number</b>  | 222636                                    |                |   |
| <b>Class</b>  | 08-08                                     |                |   |
| <b>1)Watertec (Malaysia) Sdn Bhd</b><br>Lot 6 Jalan Halba 16/16, Section 16, 40200 Shah Alam, Selangor, Malaysia              |   |                |   |
| <b>Date of Registration</b>   | 29/04/2009                                |                |   |
| <b>Title</b>  | Hose Nut                                  |                |   |
| <b>Priority NA</b>  |   |                |   |
| <b>Design Number</b>  | 210597                                    |                |  |
| <b>Class</b>  | 13-03                                     |                |   |
| <b>1)Legrand France</b><br>128, Avenue Du Marechal De Lattre-De-Tassigny, Fr-87000 Limoges (France)                           |   |                |   |
| <b>Date of Registration</b>   | 04/06/2007                                |                |   |
| <b>Title</b>  | Electrical Switch Board Containing Switch |                |   |
| <b>Priority</b>   |   |                |   |
| <b>Priority Number</b>  | <b>Date</b>                               | <b>Country</b> |   |
| 000646047   | 07/12/2006                                | OHIM           |   |

|   |   |         |
|---|---|---------|
| <b>Design Number</b>  | 210601                                    |         |
| <b>Class</b>  | 13-03                                     |         |
| <b>1)Legrand France</b><br>128, Avenue Du Marechal De Lattre-De-Tassigny, Fr-87000 Limoges (France) |   |         |
| <b>Date of Registration</b>   | 04/06/2007                                |         |
| <b>Title</b>  | Electrical Switch Board Containing Switch |         |
| <b>Priority</b>   |   |         |
| Priority Number   | Date                                      | Country |
| 000646047   | 07/12/2006                                | OHIM    |

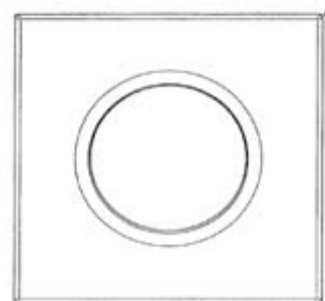

|  |            |         |
|--|------------|---------|
| <b>Design Number</b>   | 213646     |         |
| <b>Class</b>   | 24-02      |         |
| <b>1)Pz Htl Spolka Akcyjna.,</b><br>Ul. Daniszewska 4, Pl 03-230 Warszawa, Poland. |            |         |
| <b>Date of Registration</b>  | 05/12/2007 |         |
| <b>Title</b>   | Pipette    |         |
| <b>Priority</b>  |            |         |
| Priority Number  | Date       | Country |
| 000827308  | 16/11/2007 | OHIM    |

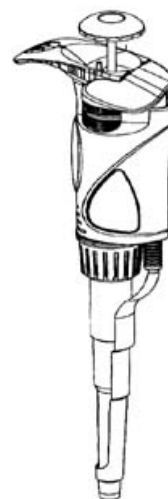



|   |            |         |
|---|------------|---------|
| <b>Design Number</b>  | 213766     |         |
| <b>Class</b>  | 12-11      |         |
| <b>1)Honda Motor Co., Ltd</b><br>1-1, Minami-Aoyama 2-Chome, Minato-Ku, Tokyo, Japan. |            |         |
| <b>Date of Registration</b>   | 17/12/2007 |         |
| <b>Title</b>  | Motorcycle |         |
| <b>Priority</b>   |            |         |
| Priority Number   | Date       | Country |
| 200730160514.4  | 20/06/2007 | China   |

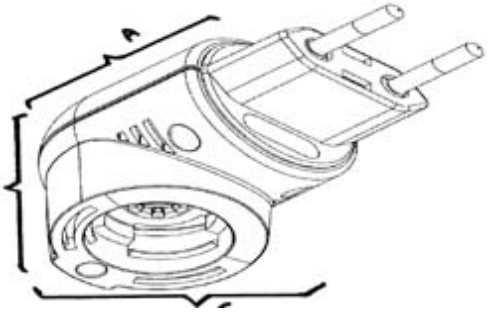

|   |                                      |  |
|---|--------------------------------------|--|
| <b>Design Number</b>  | 218160                               |  |
| <b>Class</b>  | 12-16                                |  |
| <b>1)Mindarika Pvt. Ltd.,</b><br>Vill. Nawada Fatepur, P.O. Sikanderpur Badda,<br>Manesar, Distt. Gurgaon, Haryana-122004, India. |                                      |  |
| <b>Date of Registration</b>   | 27/08/2008                           |  |
| <b>Title</b>  | Lever Combination Switch For Vehicle |  |
| <b>Priority NA</b>  |                                      |  |

|  |  |   |
|--|--|---|
| <b>Design Number</b>   | 220620                                     |  |
| <b>Class</b>   | 23-04                                      |   |
| <b>1)Zobeles Holding Spa</b><br>Italy, Via Fersina, 4, 38100 Trento, Italy |  |   |
| <b>Date of Registration</b>  | 31/12/2008                                 |   |
| <b>Title</b>   | Diffusing Evaporators Of Active Substances |   |
| <b>Priority</b>  |  |   |
| Priority Number  | Date                                       | Country   |
| 000963780  | 03/07/2008                                 | OHIM  |

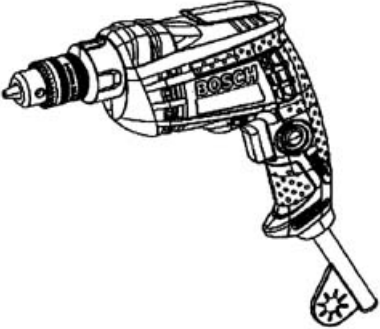
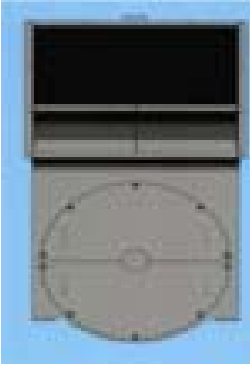
|   |            |  |
|---|------------|--|
| <b>Design Number</b>  | 220676     |  |
| <b>Class</b>  | 09-01      |  |
| <b>1)Nayasa Homeware.,</b><br>Survey No. 367/16 & 378/2 Kachigam Nani Daman, Daman-396 210, Daman Union Territories, India. |            |  |
| <b>Date of Registration</b>   | 06/01/2009 |  |
| <b>Title</b>  | Lid        |  |
| <b>Priority NA</b>  |            |  |

|   |                       |         |   |
|---|-----------------------|---------|---|
| <b>Design Number</b>  | 220818                |         |    |
| <b>Class</b>  | 08-01                 |         |   |
| <b>1)Robert Bosch GmbH.,</b><br>Postfach 30 02 20, 70442 Stuttgart, Germany.  |                       |         |   |
| <b>Date of Registration</b>   | 16/01/2009            |         |   |
| <b>Title</b>  | Electric Drills       |         |   |
| <b>Priority</b>   |                       |         |   |
| Priority Number   | Date                  | Country |   |
| 001030027   | 29/10/2008            | OHIM    |   |
| <b>Design Number</b>  | 222222                |         |    |
| <b>Class</b>  | 08-99                 |         |   |
| <b>1)Crompton Greaves Limited.,</b><br>6th Floor, Cg House, Dr Annie Besant Road, Worli, Mumbai-400 030,<br>Maharashtra, India. |                       |         |   |
| <b>Date of Registration</b>   | 31/03/2009            |         |   |
| <b>Title</b>  | Fan Cover For A Motor |         |   |
| <b>Priority NA</b>  |                       |         |   |
| <b>Design Number</b>  | 222223                |         |  |
| <b>Class</b>  | 31-00                 |         |   |
| <b>1)Crompton Greaves Limited.,</b><br>6th Floor, Cg House, Dr Annie Besant Road, Worli, Mumbai-400 030,<br>Maharashtra, India. |                       |         |   |
| <b>Date of Registration</b>   | 31/03/2009            |         |   |
| <b>Title</b>  | Mixer Grinder         |         |   |
| <b>Priority NA</b>  |                       |         |   |



|   |             |   |
|---|-------------|---|
| <b>Design Number</b>  | 222224      |  |
| <b>Class</b>  | 23-04       |   |
| <b>1)CROMPTON GREAVES LIMITED.,</b><br>6TH FLOOR, CG HOUSE, DR ANNIE BESANT ROAD,<br>WORLI, MUMBAI-400 030, MAHARASHTRA, INDIA. |             |   |
| <b>Date of Registration</b>   | 31/03/2009  |   |
| <b>Title</b>  | Ceiling Fan |   |
| <b>Priority NA</b>  |             |   |

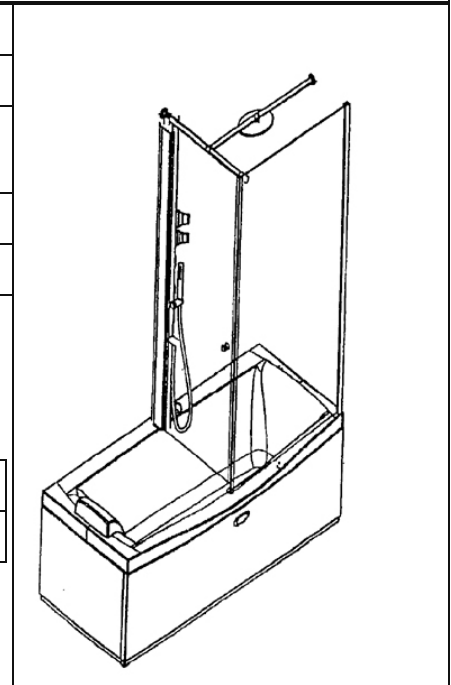

|   |            |         |
|---|------------|---------|
| <b>Design Number</b>  | 218942     |         |
| <b>Class</b>  | 23-02      |         |
| <b>1)Jacuzzi Europe Spa</b><br>S. S. Pontebbana Km. 97, 2 33098 Valvasone (Pordenone) Italy |            |         |
| <b>Date of Registration</b>   | 01/10/2008 |         |
| <b>Title</b>  | Shower Box |         |
| <b>Priority</b>   |            |         |
| Priority Number   | Date       | Country |
| 000913629-0002  | 08/04/2008 | OHIM    |

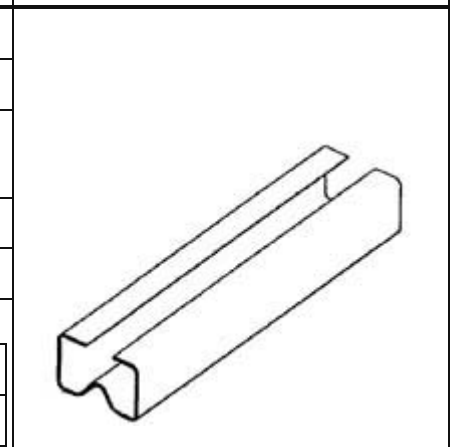

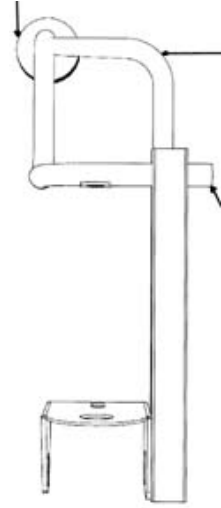

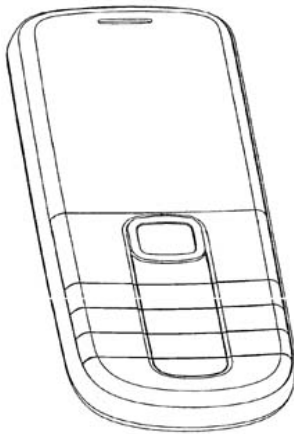
|  |                      |         |
|--|----------------------|---------|
| <b>Design Number</b>   | 221142               |         |
| <b>Class</b>   | 25-02                |         |
| <b>1)Usg Interiors, Inc.,</b><br>550 West Adams Street, Chicago, Illinois 60661-3676, Usa. |                      |         |
| <b>Date of Registration</b>  | 10/02/2009           |         |
| <b>Title</b>   | Grid Tee Face Sleeve |         |
| <b>Priority</b>  |                      |         |
| Priority Number  | Date                 | Country |
| 29/322,767   | 12/08/2008           | U.S.A.  |

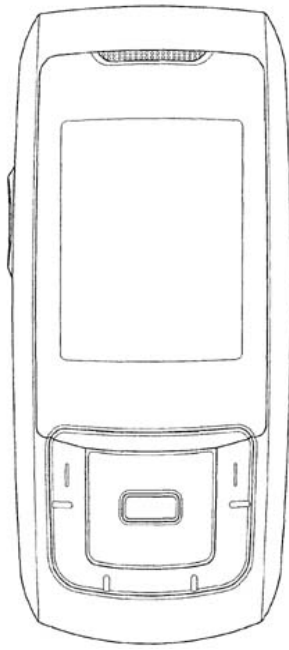

|  |   |                |   |
|--|---|----------------|---|
| <b>Design Number</b>   | 221146  |                |    |
| <b>Class</b>   | 08-05   |                |   |
| <b>1) Mathew Raymund Norton.,</b><br>24, Dapper Street, Sunnybank Hills, 4109, Queensland, Australia.        |   |                |   |
| <b>Date of Registration</b>  | 11/02/2009  |                |   |
| <b>Title</b>   | Floor Grinder Handle Provided with an Angle Bracket |                |   |
| <b>Priority</b>  |   |                |   |
| <b>Priority Number</b>   | <b>Date</b>   | <b>Country</b> |   |
| 13883/08   | 12/08/2008  | Australia      |   |
|  |   |                |   |
|  |   |                |   |
| <b>Design Number</b>   | 221191  |                |   |
| <b>Class</b>   | 09-01   |                |   |
| <b>1) M/S. United Spirits Ltd.,</b><br>Ub Tower 24, Vittal Mallya Road, Bangalore-560 001, Karnataka, India. |   |                |   |
| <b>Date of Registration</b>  | 13/02/2009  |                |   |
| <b>Title</b>   | Bottle  |                |   |
| <b>Priority NA</b>   |   |                |   |
| <b>Design Number</b>   | 221201  |                |  |
| <b>Class</b>   | 14-03   |                |   |
| <b>1) Nokia Corporation.,</b><br>Keilalahdentie 4, Fin-02150 Espoo, Finland.                                 |   |                |   |
| <b>Date of Registration</b>  | 13/02/2009  |                |   |
| <b>Title</b>   | Handset   |                |   |
| <b>Priority</b>  |   |                |   |
| <b>Priority Number</b>   | <b>Date</b>   | <b>Country</b> |   |
| 29/323,013   | 15/08/2008  | U.S.A.         |   |

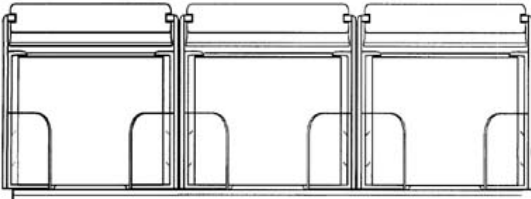
|  |               |                   |   |
|--|---------------|-------------------|---|
| <b>Design Number</b>   | 221252        |                   |    |
| <b>Class</b>   | 14-03         |                   |   |
| <b>1)Samsung Electronics Co., Ltd.</b><br>416, Maetan -Dong, Yeongtong-Gu, Suwon-SI, Gyeonggi-Do, Korea.                   |               |                   |   |
| <b>Date of Registration</b>  | 16/02/2009    |                   |   |
| <b>Title</b>   | Mobile Phone  |                   |   |
| <b>Priority</b>  |               |                   |   |
| <b>Priority Number</b>   | <b>Date</b>   | <b>Country</b>    |   |
| 30-2008-0052229  | 04/12/2008    | Republic of Korea |   |
| <b>Priority NA</b>   |               |                   |   |
| <b>Priority</b>  |               |                   |   |
| <b>Design Number</b>   | 221254        |                   |   |
| <b>Class</b>   | 23-02         |                   |   |
| <b>1)Shreeji Krupa Industries</b><br>Gondal Road, Near Lathiya Motor Garage, Rajkot, Gujarat, India, Pin Code No. 360004   |               |                   |   |
| <b>Date of Registration</b>  | 17/02/2009    |                   |   |
| <b>Title</b>   | Bathroom Rack |                   |   |
| <b>Priority NA</b>   |               |                   |   |
| <b>Design Number</b>   | 221255        |                   |  |
| <b>Class</b>   | 23-02         |                   |   |
| <b>1)Shreeji Krupa Industries.,</b><br>Gondal Road, Near Lathiya Motor Garage, Rajkot, Gujarat, India, Pin Code No. 360004 |               |                   |   |
| <b>Date of Registration</b>  | 17/02/2009    |                   |   |
| <b>Title</b>   | Robe Hook     |                   |   |
| <b>Priority NA</b>   |               |                   |   |

|  |               |         |   |
|--|---------------|---------|---|
| <b>Design Number</b>   | 221275        |         |     |
| <b>Class</b>   | 20-02         |         |   |
| <b>1)The Procter &amp; Gamble Company.,</b><br>One Procter & Gamble Plaza, Cincinnati, Ohio-45202, USA.  |               |         |   |
| <b>Date of Registration</b>  | 17/02/2009    |         |   |
| <b>Title</b>   | Dispenser     |         |   |
| <b>Priority</b>  |               |         |   |
| Priority Number  | Date          | Country |   |
| 29/323,089   | 18/08/2008    | U.S.A.  |   |
| <b>Design Number</b>   | 221282        |         |    |
| <b>Class</b>   | 06-09         |         |   |
| <b>1)Mr. Chinnappa Gounder Thangaraj, Mrs. Chinnappa Gounder</b><br><b>Arukkani Ammal &amp; Mrs. Thangaraj Haripriya.,</b><br>Sf 150/B, Sanjay Nagar, Erode Main Road, Karur-639 002, Tn, India. |               |         |   |
| <b>Date of Registration</b>  | 18/02/2009    |         |   |
| <b>Title</b>   | Seat Cushion  |         |   |
| <b>Priority NA</b>   |               |         |   |
| <b>Design Number</b>   | 221294        |         |  |
| <b>Class</b>   | 07-02         |         |   |
| <b>1)Hasmukh Karelia.,</b><br>Gala No. 5, Plot No. 29p, Opp Crescent Industrial Estate, Off Kanjur Village Road, Kanjurmarg (East), Mumbai-400 042, Maharashtra, India.                          |               |         |   |
| <b>Date of Registration</b>  | 18/02/2009    |         |   |
| <b>Title</b>   | L.P Gas Stove |         |   |
| <b>Priority NA</b>   |               |         |   |

|   |                                  |         |
|---|----------------------------------|---------|
| <b>Design Number</b>  | 221354                           |         |
| <b>Class</b>  | 13-03                            |         |
| <b>1)Beluk Gmbh.,</b><br>Taubenstr.1, Postfach 1153 86951, Schongau Deutschland Alemania. |                                  |         |
| <b>Date of Registration</b>   | 23/02/2009                       |         |
| <b>Title</b>  | Housing For An Electronic Device |         |
| <b>Priority</b>   |                                  |         |
| Priority Number   | Date                             | Country |
| 001046627   | 26/11/2008                       | Germany |

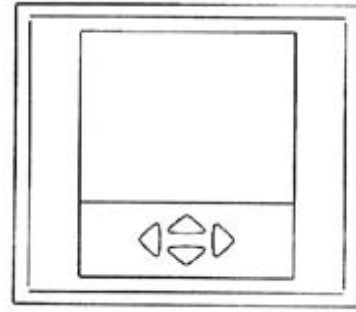



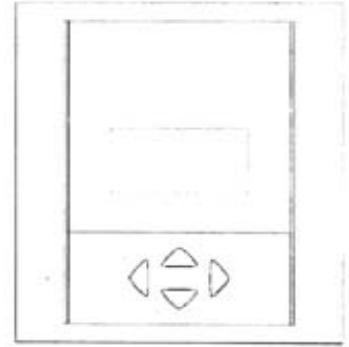

|  |                                  |         |
|--|----------------------------------|---------|
| <b>Design Number</b>   | 221355                           |         |
| <b>Class</b>   | 13-03                            |         |
| <b>1)Beluk Gmbh.,</b><br>Taubenstr. 1, Postfach 1153 86951, Schongau Deutschland Alemania. |                                  |         |
| <b>Date of Registration</b>  | 23/02/2009                       |         |
| <b>Title</b>   | Housing For An Electronic Device |         |
| <b>Priority</b>  |                                  |         |
| Priority Number  | Date                             | Country |
| 001046627-0002   | 26/11/2008                       | Germany |





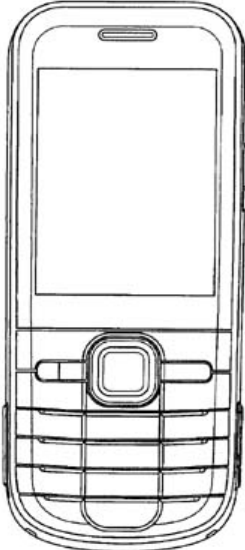

|   |            |  |
|---|------------|--|
| <b>Design Number</b>  | 221362     |  |
| <b>Class</b>  | 26-02      |  |
| <b>1)Eveready Industries India Ltd.,</b><br>1 Middleton Street, Kolkata-700 071, Wb, India. |            |  |
| <b>Date of Registration</b>   | 23/02/2009 |  |
| <b>Title</b>  | Flashlight |  |
| <b>Priority NA</b>  |            |  |

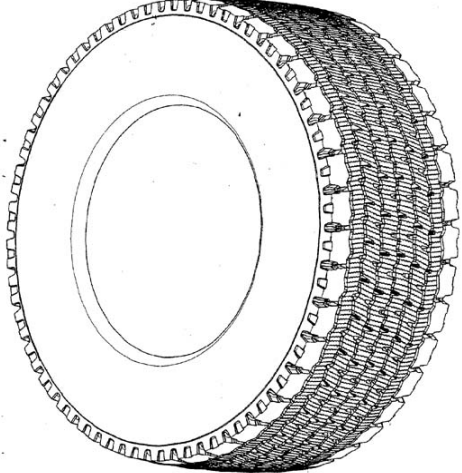
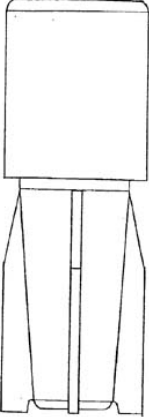



|  |                     |                |  |
|--|---------------------|----------------|--|
| <b>Design Number</b>   | 217808              |                |   |
| <b>Class</b>   | 24-02               |                |  |
| <b>1)Unisas Group</b><br>Resident G-712-A, Road No.-9 F 3, V.K.I. Area, Jaipur {Rajasthan} India   |                     |                |  |
| <b>Date of Registration</b>  | 14/08/2008          |                |  |
| <b>Title</b>   | Scissor             |                |  |
| <b>Priority NA</b>   |                     |                |  |
| <b>Design Number</b>   | 217809              |                |   |
| <b>Class</b>   | 24-02               |                |  |
| <b>1)Unisas Group Indian</b><br>Resident G-712-A, Road No.-9, F 3, V.K.I. Area, Jaipur {Rajasthan} |                     |                |  |
| <b>Date of Registration</b>  | 14/08/2008          |                |  |
| <b>Title</b>   | Matzen Baum Scissor |                |  |
| <b>Priority NA</b>   |                     |                |  |
| <b>Design Number</b>   | 221973              |                |  |
| <b>Class</b>   | 14-03               |                |  |
| <b>1)Nokia Corporation.,</b><br>Keilalahdentie 4, Fin-02150 Espoo, Finland.                        |                     |                |  |
| <b>Date of Registration</b>  | 26/03/2009          |                |  |
| <b>Title</b>   | Handset             |                |  |
| <b>Priority</b>  |                     |                |  |
| <b>Priority Number</b>   | <b>Date</b>         | <b>Country</b> |  |
| 29/325,202   | 26/09/2008          | U.S.A.         |  |
|  |                     |                |  |
|  |                     |                |  |

|   |                      |                |   |
|---|----------------------|----------------|---|
| <b>Design Number</b>  | 221981               |                |    |
| <b>Class</b>  | 06-02                |                |   |
| <b>1)Godrej &amp; Boyce Mfg. Co. Ltd.,</b><br>Pirojshanagar, Vikhroli, Mumbai-400 079, Maharashtra, India.      |                      |                |   |
| <b>Date of Registration</b>   | 26/03/2009           |                |   |
| <b>Title</b>  | Semi Fowler Bed      |                |   |
| <b>Priority NA</b>  |                      |                |   |
| <b>Design Number</b>  | 221999               |                |    |
| <b>Class</b>  | 12-15                |                |   |
| <b>1)Michelin Recherche Et Technique S.A.,</b><br>Route Louis-Braille 10, Ch-1763, Granges-Paccot, Switzerland. |                      |                |   |
| <b>Date of Registration</b>   | 27/03/2009           |                |   |
| <b>Title</b>  | Tyre                 |                |   |
| <b>Priority</b>   |                      |                |   |
| <b>Priority Number</b>  | <b>Date</b>          | <b>Country</b> |   |
| 29/325,358  | 30/09/2008           | U.S.A.         |   |
| <b>Design Number</b>  | 222005               |                |  |
| <b>Class</b>  | 24-01                |                |   |
| <b>1)American Sterilizer Company.,</b><br>5960 Heisley Road, Mentor, Ohio 44060.                                |                      |                |   |
| <b>Date of Registration</b>   | 27/03/2009           |                |   |
| <b>Title</b>  | Biological Indicator |                |   |
| <b>Priority</b>   |                      |                |   |
| <b>Priority Number</b>  | <b>Date</b>          | <b>Country</b> |   |
| 29/325,371  | 30/09/2008           | U.S.A.         |   |

|   |                      |  |
|---|----------------------|--|
| <b>Design Number</b>  | 222018               |    |
| <b>Class</b>  | 14-03                |  |
| <b>1) Nokia Corporation</b><br>Keilalahdentie 4, Fin-02150 Espoo, Finland.  |                      |  |
| <b>Date of Registration</b>   | 27/03/2009           |  |
| <b>Title</b>  | Handset              |  |
| <b>Priority NA</b>  |                      |  |
| <b>Design Number</b>  | 222057               |   |
| <b>Class</b>  | 13-99                |  |
| <b>1) Crompton Greaves Limited.,</b><br>6th Floor, Cg House, Dr Annie Besant Road, Worli, Mumbai-400 030, Maharashtra, India. |                      |  |
| <b>Date of Registration</b>   | 30/03/2009           |  |
| <b>Title</b>  | Pcb Checking Fixture |  |
| <b>Priority NA</b>  |                      |  |
| <b>Design Number</b>  | 222067               |  |
| <b>Class</b>  | 13-03                |  |
| <b>1) Crompton Greaves Limited.,</b><br>6th Floor, Cg House, Dr Annie Besant Road, Worli, Mumbai-400 030, Maharashtra, India. |                      |  |
| <b>Date of Registration</b>   | 30/03/2009           |  |
| <b>Title</b>  | Fan Switch           |  |
| <b>Priority NA</b>  |                      |  |

|   |             |   |
|---|-------------|---|
| <b>Design Number</b>  | 222073      |    |
| <b>Class</b>  | 02-04       |   |
| <b>1)X O India ( A Unit Of X O Foorwear Pvt. Ltd),,<br/>A-124, Phase-II, Mangol Puri Industrial Area, Delhi-110 041, India.</b>   |             |   |
| <b>Date of Registration</b>   | 30/03/2009  |   |
| <b>Title</b>  | Footwear    |   |
| <b>Priority NA</b>  |             |   |
| <b>Design Number</b>  | 222120      |     |
| <b>Class</b>  | 23-04       |   |
| <b>1)Crompton Greaves Limited.,<br/>6th Floor, Cg House, Dr Annie Besant Road, Worli,<br/>Mumbai-400 030, Maharashtra, India.</b> |             |   |
| <b>Date of Registration</b>   | 31/03/2009  |   |
| <b>Title</b>  | Ceiling Fan |   |
| <b>Priority NA</b>  |             |   |
| <b>Design Number</b>  | 222127      |  |
| <b>Class</b>  | 13-01       |   |
| <b>1)Crompton Greaves Limited.,<br/>6th Floor, Cg House, Dr Annie Besant Road, Worli, Mumbai-400 030,<br/>Maharashtra, India.</b> |             |   |
| <b>Date of Registration</b>   | 31/03/2009  |   |
| <b>Title</b>  | Motor       |   |
| <b>Priority NA</b>  |             |   |

|  |                           |         |   |
|--|---------------------------|---------|---|
| <b>Design Number</b>   | 214599                    |         |    |
| <b>Class</b>   | 12-11                     |         |   |
| <b>1)Honda Motor Co., Ltd.,</b><br>1-1, Minami-Aoyama 2-Chome, Minato-Ku, Tokyo, Japan.  |                           |         |   |
| <b>Date of Registration</b>  | 08/02/2008                |         |   |
| <b>Title</b>   | Motorcycle                |         |   |
| <b>Priority</b>  |                           |         |   |
| Priority Number  | Date                      | Country |   |
| 2007-021816  | 09/08/2007                | Japan   |   |
| <b>Design Number</b>   | 219361                    |         |    |
| <b>Class</b>   | 13-03                     |         |   |
| <b>1)M/s. Premier Elmech Systems Pvt. Ltd.</b><br>Premier House, #2, Saravana Street, South Boag Road, T. Nagar, Chennai<br>600017 Tamil Nadu, India |                           |         |   |
| <b>Date of Registration</b>  | 21/10/2008                |         |   |
| <b>Title</b>   | Electric Power Stabilizer |         |   |
| <b>Priority NA</b>   |                           |         |   |
| <b>Design Number</b>   | 219420                    |         |  |
| <b>Class</b>   | 28-03                     |         |   |
| <b>1)S. B. International</b><br>413-414, Imperial Towers, C-Block Community Center Naraina Vihar,<br>New Delhi-110028, India                         |                           |         |   |
| <b>Date of Registration</b>  | 23/10/2008                |         |   |
| <b>Title</b>   | Mixing Pallate            |         |   |
| <b>Priority NA</b>   |                           |         |   |

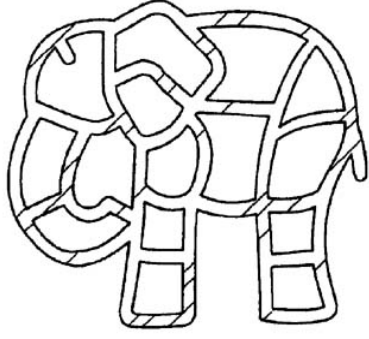
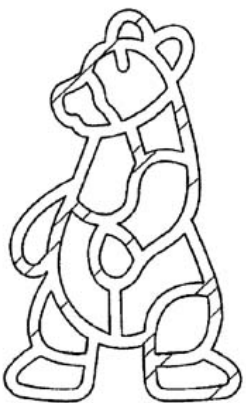
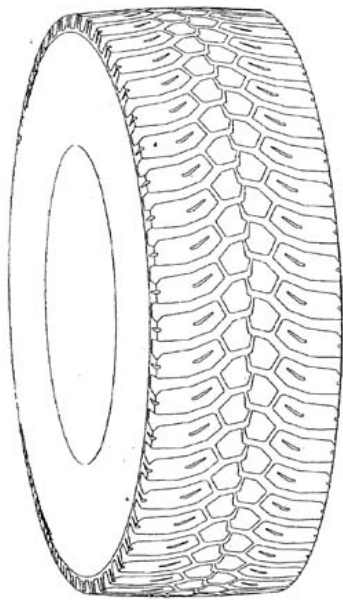

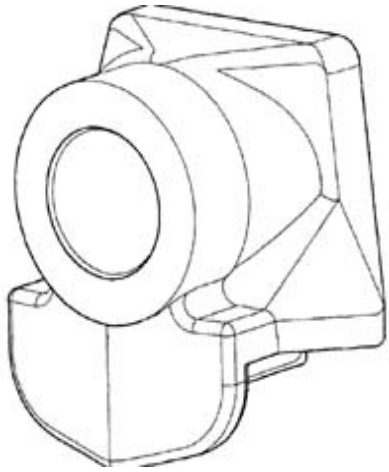
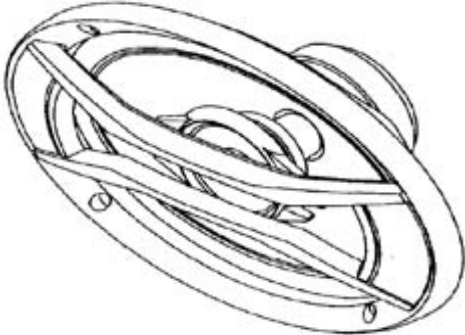
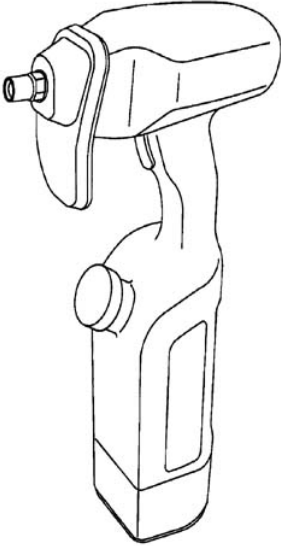
|   |                             |         |   |
|---|-----------------------------|---------|---|
| <b>Design Number</b>  | 221379                      |         |    |
| <b>Class</b>  | 01-01                       |         |   |
| <b>1)Kraft Food Global Brands Llc.,</b><br>Three Lakes Drive, Northfield, Illinois 60093, Usa.    |                             |         |   |
| <b>Date of Registration</b>   | 24/02/2009                  |         |   |
| <b>Title</b>  | Animal-Shaped Food Product  |         |   |
| <b>Priority</b>   |                             |         |   |
| Priority Number   | Date                        | Country |   |
| 29/323,403  | 25/08/2008                  | U.S.A.  |   |
| <b>Design Number</b>  | 221382                      |         |   |
| <b>Class</b>  | 01-01                       |         |   |
| <b>1)Kraft Food Global Brands Llc.,</b><br>Three Lakes Drive, Northfield, Illinois 60093, Usa.    |                             |         |   |
| <b>Date of Registration</b>   | 24/02/2009                  |         |   |
| <b>Title</b>  | Animal-Shaped Foods Product |         |   |
| <b>Priority</b>   |                             |         |   |
| Priority Number   | Date                        | Country |   |
| 29/323,403  | 25/08/2008                  | U.S.A.  |   |
| <b>Design Number</b>  | 221418                      |         |  |
| <b>Class</b>  | 12-15                       |         |   |
| <b>1)Societe De Technologie Michelin.,</b><br>23, Rue Breschet - 63000, Clermont-Ferrand, France. |                             |         |   |
| <b>Date of Registration</b>   | 26/02/2009                  |         |   |
| <b>Title</b>  | Tyre                        |         |   |
| <b>Priority</b>   |                             |         |   |
| Priority Number   | Date                        | Country |   |
| 08/3911   | 04/09/2008                  | France  |   |

|   |                                |                |   |
|---|--------------------------------|----------------|---|
| <b>Design Number</b>  | 221423                         |                |    |
| <b>Class</b>  | 08-05                          |                |   |
| <b>1)Everpads Co., Ltd.,</b><br>83, 32nd Road, Taichung Industrial Park, Taichung, 40768, Taiwan, China.          |                                |                |   |
| <b>Date of Registration</b>   | 26/02/2009                     |                |   |
| <b>Title</b>  | Drill-Shaver Holding Apparatus |                |   |
| <b>Priority NA</b>  |                                |                |   |
| <b>Design Number</b>  | 221461                         |                |   |
| <b>Class</b>  | 14-01                          |                |   |
| <b>1)SONY CORPORATION.,</b><br>1-7-1 KONAN, MINATO-KU, TOKYO, JAPAN.  |                                |                |   |
| <b>Date of Registration</b>   | 27/02/2009                     |                |   |
| <b>Title</b>  | SPEAKER                        |                |   |
| <b>Priority NA</b>  |                                |                |   |
| <b>Design Number</b>  | 221474                         |                |  |
| <b>Class</b>  | 09-01                          |                |   |
| <b>1)Global Opportunities Investment Group, Llc.,</b><br>21308, John Milless Drive, Rogers, Minnesota 55374, Usa. |                                |                |   |
| <b>Date of Registration</b>   | 02/03/2009                     |                |   |
| <b>Title</b>  | Spray Bottle                   |                |   |
| <b>Priority</b>   |                                |                |   |
| <b>Priority Number</b>  | <b>Date</b>                    | <b>Country</b> |   |
| 29/323,877  | 02/09/2008                     | U.S.A.         |   |

|   |            |   |
|---|------------|---|
| <b>Design Number</b>  | 221502     |  |
| <b>Class</b>  | 09-01      |   |
| <b>1)Majaria Foods (P) Ltd.,</b><br>Ab, Dside, Rohtak Road, Udyog Nagar, New Delhi-110041, India. |            |   |
| <b>Date of Registration</b>   | 04/03/2009 |   |
| <b>Title</b>  | Bottle     |   |
| <b>Priority NA</b>  |            |   |

|  |                  |                |   |
|--|------------------|----------------|---|
| <b>Design Number</b>   | 221517           |                |  |
| <b>Class</b>   | 14-02            |                |   |
| <b>1)Bancolini Symbol S.R.L.,</b><br>Via Emilia, 292 Loc. La Cicogna 40068 San Lazzaro Di Savena Bologna, Italy. |                  |                |   |
| <b>Date of Registration</b>  | 04/03/2009       |                |   |
| <b>Title</b>   | Bar Code Readers |                |   |
| <b>Priority</b>  |                  |                |   |
| Priority Number  | Date             | Country        |   |
| 000999412-0001   | 09/09/2008       | EUROPEAN UNION |   |

|  |            |  |   |
|--|------------|--|---|
| <b>Design Number</b>   | 221537     |  |  |
| <b>Class</b>   | 21-01      |  |   |
| <b>1)Anindita Toy Company Private Limited</b><br>SC 1/12, Kohinoor Estate, Behind Kamal Nayan Bajaj Udyan, Mumbai-Pune Road, Pune-411003, Maharashtra, India |            |  |   |
| <b>Date of Registration</b>  | 06/03/2009 |  |   |
| <b>Title</b>   | Toy Set    |  |   |
| <b>Priority NA</b>   |            |  |   |

|  |                |   |
|--|----------------|---|
| <b>Design Number</b>   | 221539         |    |
| <b>Class</b>   | 21-01          |   |
| <b>1)Anindita Toy Company Private Limited</b><br>SC 1/12, Kohinoor Estate, Behind Kamal Nayan Bajaj Udyan, Mumbai-Pune Road, Pune-411003, Maharashtra, India |                |   |
| <b>Date of Registration</b>  | 06/03/2009     |   |
| <b>Title</b>   | Toy Set        |   |
| <b>Priority NA</b>   |                |   |
| <b>Design Number</b>   | 221548         |    |
| <b>Class</b>   | 23-02          |   |
| <b>1)Shreeji Krupa Industries</b><br>Gondal Road, Near Lathiya Motor Garage, Rajkot, Gujarat, India, Pin Code No. 360004                                     |                |   |
| <b>Date of Registration</b>  | 06/03/2009     |   |
| <b>Title</b>   | Tumbler Holder |   |
| <b>Priority NA</b>   |                |   |
| <b>Design Number</b>   | 221550         |  |
| <b>Class</b>   | 23-02          |   |
| <b>1)Shreeji Krupa Industries.,</b><br>Gondal Road, Near Lathiya Motor Garage, Rajkot, Gujarat, India, Pin Code No. 360004                                   |                |   |
| <b>Date of Registration</b>  | 06/03/2009     |   |
| <b>Title</b>   | Napkin Bar     |   |
| <b>Priority NA</b>   |                |   |

|  |            |         |
|--|------------|---------|
| <b>Design Number</b>   | 221588     |         |
| <b>Class</b>   | 23-01      |         |
| <b>1)Kohler Co.,</b><br>444 Highland Drive, Kohler, Wisconsin, 53044, Usa. |            |         |
| <b>Date of Registration</b>  | 09/03/2009 |         |
| <b>Title</b>   | Faucet     |         |
| <b>Priority</b>  |            |         |
| Priority Number  | Date       | Country |
| 29/324,345   | 10/09/2008 | U.S.A.  |

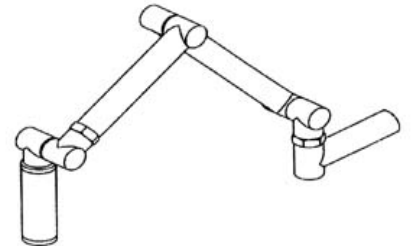

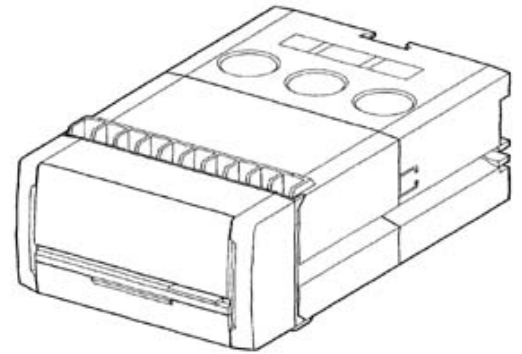

|  |                                   |              |
|--|-----------------------------------|--------------|
| <b>Design Number</b>   | 221597                            |              |
| <b>Class</b>   | 14-02                             |              |
| <b>1)Ls Industrial Systems Co. Ltd.,</b><br>1026-6, Hogye-Dong, Dongahn-Gu, Ahnyang-Shi, Gyeonggi-Do, Korea. |                                   |              |
| <b>Date of Registration</b>  | 09/03/2009                        |              |
| <b>Title</b>   | Electronic Motor Protection Relay |              |
| <b>Priority</b>  |                                   |              |
| Priority Number  | Date                              | Country      |
| 30-2008-0041726  | 26/09/2008                        | Korea(South) |



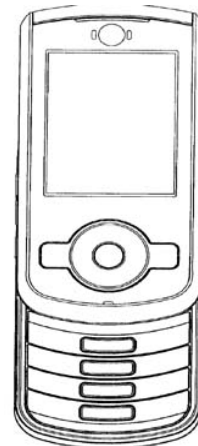

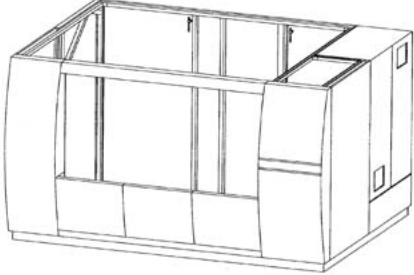

|  |                      |         |
|--|----------------------|---------|
| <b>Design Number</b>   | 221600               |         |
| <b>Class</b>   | 14-03                |         |
| <b>1)Motorola, Inc.,</b><br>1303 East Algonquin Road, Schaumburg, Illinois 60196, Usa. |                      |         |
| <b>Date of Registration</b>  | 09/03/2009           |         |
| <b>Title</b>   | Communication Device |         |
| <b>Priority</b>  |                      |         |
| Priority Number  | Date                 | Country |
| 29/324,774   | 19/09/2008           | U.S.A.  |



|   |                      |         |   |
|---|----------------------|---------|---|
| <b>Design Number</b>  | 219103               |         |  |
| <b>Class</b>  | 15-99                |         |   |
| <b>1)Zahoransky Ag</b><br>Anton-Zahoransky-Str. 1 79674 Todtnau Germany |                      |         |   |
| <b>Date of Registration</b>   | 13/10/2008           |         |   |
| <b>Title</b>  | Casings For Machines |         |   |
| <b>Priority</b>   |                      |         |   |
| Priority Number   | Date                 | Country |   |
| 000918495-0026  | 16/04/2008           | OHIM    |   |

|  |                            |  |  |
|--|----------------------------|--|--|
| <b>Design Number</b>   | 219148                     |  |  |
| <b>Class</b>   | 12-16                      |  |  |
| <b>1)Minda Industries Ltd.,</b><br>Vill Nawada Fatepur, P.O. Sikanderpur Badda, Manesar,<br>Distt. Gurgaon, Haryana-122004, India  |                            |  |  |
| <b>Date of Registration</b>  | 14/10/2008                 |  |  |
| <b>Title</b>   | Sweat Free Handle-Bar Grip |  |  |
| <b>Priority NA</b>   |                            |  |  |
| <b>Design Number</b>   | 219150                     |  |  |
| <b>Class</b>   | 12-16                      |  |  |
| <b>1)Minda Industries Ltd.,</b><br>Vill. Nawada Fatepur, P.O. Sikanderpur Badda, Manesar, Distt.<br>Gurgaon, Haryana-122004, India |                            |  |  |
| <b>Date of Registration</b>  | 14/10/2008                 |  |  |
| <b>Title</b>   | Sweat Free Handle Bar Grip |  |  |
| <b>Priority NA</b>   |                            |  |  |

|  |                            |  |  |
|--|----------------------------|--|--|
| <b>Design Number</b>   | 219150                     |  |  |
| <b>Class</b>   | 12-16                      |  |  |
| <b>1)Minda Industries Ltd.,</b><br>Vill. Nawada Fatepur, P.O. Sikanderpur Badda, Manesar, Distt.<br>Gurgaon, Haryana-122004, India |                            |  |  |
| <b>Date of Registration</b>  | 14/10/2008                 |  |  |
| <b>Title</b>   | Sweat Free Handle Bar Grip |  |  |
| <b>Priority NA</b>   |                            |  |  |

|   |                    |         |   |
|---|--------------------|---------|---|
| <b>Design Number</b>  | 219152             |         |    |
| <b>Class</b>  | 12-16              |         |   |
| <b>1)Minda Industries Ltd.,</b><br>Vill. Nawada Fatepur, P.O. Sikanderpur Badda, Manesar, Distt. Gurgaon, Haryana-122004, India |                    |         |   |
| <b>Date of Registration</b>   | 14/10/2008         |         |   |
| <b>Title</b>  | Handle Bar Switch  |         |   |
| <b>Priority NA</b>  |                    |         |   |
| <b>Design Number</b>  | 219314             |         |   |
| <b>Class</b>  | 10-06              |         |   |
| <b>1)Werma Signaltechnik GmbH+Co. Kg</b><br>78604 Rietheim - Weilheim, Germany  |                    |         |   |
| <b>Date of Registration</b>   | 17/10/2008         |         |   |
| <b>Title</b>  | Signal Apparatus   |         |   |
| <b>Priority</b>   |                    |         |   |
| Priority Number   | Date               | Country |   |
| 40 2008 001 918.0   | 17/04/2008         | Germany |   |
| <b>Design Number</b>  | 219329             |         |  |
| <b>Class</b>  | 26-05              |         |   |
| <b>1)Koninklijke Philips Electronics N.V.,</b><br>Groenewoudseweg 1, 5621 Ba Eindhoven, The Netherlands.,                       |                    |         |   |
| <b>Date of Registration</b>   | 20/10/2008         |         |   |
| <b>Title</b>  | Lighting Equipment |         |   |
| <b>Priority</b>   |                    |         |   |
| Priority Number   | Date               | Country |   |
| 000920467   | 21/04/2008         | OHIM    |   |

|  |                 |                |
|--|-----------------|----------------|
| <b>Design Number</b>                                       | 221706          |                |
| <b>Class</b>   | 15-99           |                |
| <b>1)Aktiebolaget Skf.,</b><br>Se-415 50 Goteborg, Sweden. |                 |                |
| <b>Date of Registration</b>                                | 16/03/2009      |                |
| <b>Title</b>   | Bearing Housing |                |
| <b>Priority</b>  |                 |                |
| Priority Number  | Date            | Country        |
| 001005110  | 18/09/2008      | EUROPEAN UNION |

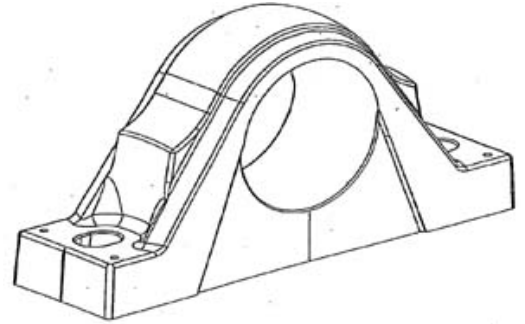

|   |                      |         |
|---|----------------------|---------|
| <b>Design Number</b>  | 221803               |         |
| <b>Class</b>  | 23-04                |         |
| <b>1)Reckitt Benckiser (Uk) Limited.,</b><br>103-105 Bath Road, Slough, Berkshire, SL1 3UH, UK. |                      |         |
| <b>Date of Registration</b>   | 20/03/2009           |         |
| <b>Title</b>  | Air Freshener Device |         |
| <b>Priority</b>   |                      |         |
| Priority Number   | Date                 | Country |
| 001011381-0002  | 30/09/2008           | OHIM    |



|  |                     |  |
|--|---------------------|--|
| <b>Design Number</b>   | 221824              |  |
| <b>Class</b>   | 15-01               |  |
| <b>1)Greaves Cotton Limited</b><br>Industry Manor, Appasaheb Marathe Marg, Prabhadevi, Mumbai 400025,<br>State of Maharashtra, India |                     |  |
| <b>Date of Registration</b>  | 20/03/2009          |  |
| <b>Title</b>   | Oil Sump For Engine |  |
| <b>Priority NA</b>   |                     |  |



|   |                                       |          |
|---|---------------------------------------|----------|
| <b>Design Number</b>  | 221869                                |          |
| <b>Class</b>  | 14-99                                 |          |
| <b>1)Clipsal Australia Pty Ltd.,</b><br>2 Solent Circuit, Norwest Business Park, Baulkam Hills, Sydney, Nsw<br>2153, Australia. |                                       |          |
| <b>Date of Registration</b>   | 23/03/2009                            |          |
| <b>Title</b>  | Docking Station for Electronic Device |          |
| <b>Priority</b>   |                                       |          |
| Priority Number   | Date                                  | Country  |
| 0802352.5M001   | 25/09/2008                            | Hongkong |



|   |            |  |
|---|------------|--|
| <b>Design Number</b>  | 221899     |  |
| <b>Class</b>  | 23-03      |  |
| <b>1)Crompton Greaves Limited.,</b><br>6th Floor, Cg House, Dr Annie Besant Road, Worli, Mumbai-400 030,<br>Maharashtra, India. |            |  |
| <b>Date of Registration</b>   | 24/03/2009 |  |
| <b>Title</b>  | Heater     |  |
| <b>Priority NA</b>  |            |  |



|   |            |  |
|---|------------|--|
| <b>Design Number</b>  | 221900     |  |
| <b>Class</b>  | 23-03      |  |
| <b>1)Crompton Greaves Limited.,</b><br>6th Floor, Cg House, Dr Annie Besant Road, Worli, Mumbai-400 030,<br>Maharashtra, India. |            |  |
| <b>Date of Registration</b>   | 24/03/2009 |  |
| <b>Title</b>  | Heater     |  |
| <b>Priority NA</b>  |            |  |

