



CONTINUED FROM PART- 1

INTRODUCTION

In view of the recent amendment made in the Designs (Amendment) Rules, 2008 with effect from 17/06/2008, Publication of the matter relating to Designs is being published in the Official Journal of The Patent Office. This Journal is being published on weekly basis on every Friday covering the various proceedings on Designs as required according to the provisions of under Rule 22, 25, 27 and 39 of the Design (Amendment) Rules, 2008. All the enquiries on this Official Journal and other information as required by the public should be addressed to the Controller General of Patents, Designs & Trade Marks. Suggestions and comments are requested from all quarters so that the content can be enriched.

REGISTRATION OF DESIGNS

The following designs have been registered. They are now open for public inspection. In the following each entry the Date of Registration is shown. The Priority Number, Priority Date and Priority Country are also shown

Design Number	221052	
Class	08-07	
1)E-Square Alliance (P) Ltd., 512, New Delhi House, Bara Khamba Road, New Delhi-110001, India.		
Date of Registration	02/02/2009	
Title	Hasp	
Priority NA		
Design Number	221053	
Class	08-07	
1)E-Square Alliance (P) Ltd., 512, New Delhi House, Bara Khamba Road, New Delhi-110001, India.		
Date of Registration	02/02/2009	
Title	Hasp	
Priority NA		
Design Number	221162	
Class	23-02	
1)Hindustan Sanitaryware & Industries Limited, Bahadurgarh-124507, Haryana, India.		
Date of Registration	12/02/2009	
Title	Cistern	
Priority NA		

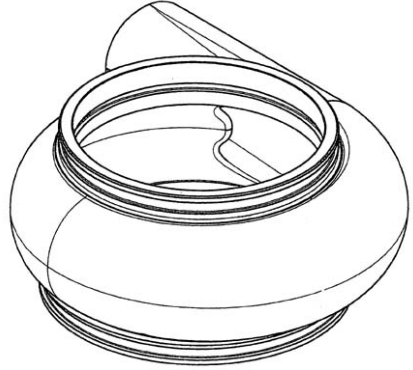
Design Number	221193		
Class	15-02		
1)Weir Minerals Australia Ltd., 1 Marden Street, Artarmon, New South Wales 2064, Australia.			
Date of Registration	13/02/2009		
Title	Pump Liner		
Priority			
Priority Number	Date	Country	
13909/2008	14/08/2008	Australia	

Design Number	219149		
Class	12-16		
1)Minda Industries Ltd., Vill Nawada Fatepur, P.O. Sikandepur Badda, Manesar, Distt. Gurgaon, Haryana-122004, India			
Date of Registration	14/10/2008		
Title	Illuminated Handle-Bar Grip With Rigid End		
Priority NA			

Design Number	221536		
Class	21-01		
1)Anindita Toy Company Private Limited SC 1/12, Kohinoor Estate, Behind Kamal Nayan Bajaj Udyan, Mumbai-Pune Road, Pune-411003, Maharashtra, India			
Date of Registration	06/03/2009		
Title	"Toy Set"		
Priority NA			

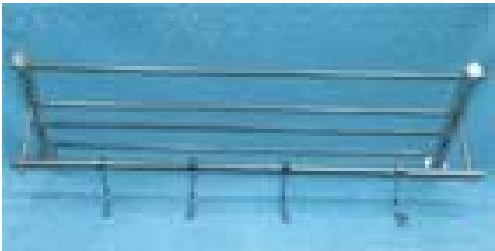
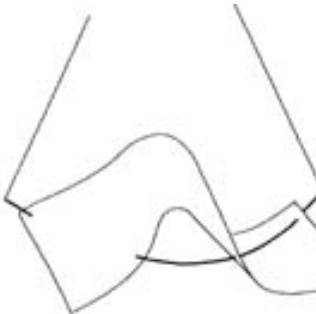
Design Number	221542		
Class	21-01		
1)Anindita Toy Company Private Limited SC 1/12, Kohinoor Estate, Behind Kamal Nayan Bajaj Udyan, Mumbai-Pune Road, Pune-411003, Maharashtra, India			
Date of Registration	06/03/2009		
Title	Toy Set		
Priority NA			
Design Number	221549		
Class	23-02		
1)Shreeji Krupa Industries Gondal Road, Near Lathiya Motor Garage, Rajkot, Gujarat, India, Pin Code No. 360004			
Date of Registration	06/03/2009		
Title	BATHROOM HOLDER		
Priority NA			
Design Number	221553		
Class	26-05		
1)Koninklijke Philips Electronics N.V., Groenewoudseweg 1, 5621 Ba Eindhoven, The Netherlands.,			
Date of Registration	06/03/2009		
Title	Luminaire		
Priority			
Priority Number	Date	Country	
001000293	10/09/2008	OHIM	

Design Number	221565	
Class	13-01	
1)Abb Ab., Ingenjor Baaths Gata 11, 721 83 Vasteras, Sweden.		
Date of Registration	06/03/2009	
Title	Motor	
Priority		
Priority Number	Date	Country
001005144-001	18/09/2008	EUROPEAN UNION

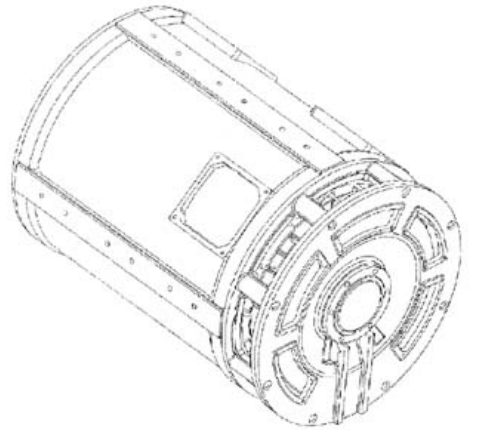

Design Number	221707	
Class	03-01	
1)Orbit Creation Shop No. 3, Indira Vihar, Himanshu Rai Road, Opp. Bombay Talkies Gate, Malad (West), Mumbai-400 064, Maharashtra, India.		
Date of Registration	17/03/2009	
Title	Jewel Case	
Priority NA		





Design Number	221715	
Class	13-01	
1)Crompton Greaves Limited., 6th Floor, Cg House, Dr Annie Besant Road, Worli, Mumbai-400 030, Maharashtra, India.		
Date of Registration	17/03/2009	
Title	Motor	
Priority NA		





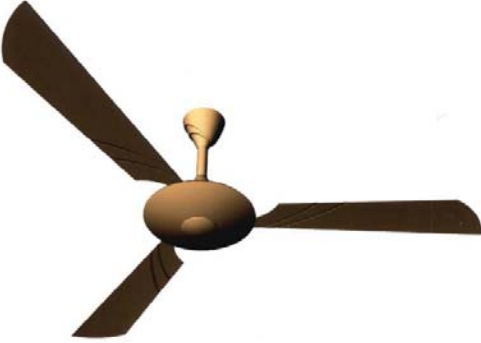

Design Number	221716	
Class	13-01	
1)Crompton Greaves Limited., 6th Floor, Cg House, Dr Annie Besant Road, Worli, Mumbai-400 030, Maharashtra, India.		
Date of Registration	17/03/2009	
Title	Alternator	
Priority NA		
Design Number	221234	
Class	05-05	
1)Charming Apparels (P) Ltd., 402-405, 1st Floor, Main Road, Chandni Chowk, Delhi-110 006, India.		
Date of Registration	16/02/2009	
Title	Textile Fabric	
Priority NA		
Design Number	213777	
Class	15-03	
1)Standard Agriculture Works., Standard Chowk, Bathinda Road, Barnala-148 101, Punjab, India.		
Date of Registration	17/12/2007	
Title	Harvester	
Priority NA		



Design Number	221753		
Class	26-05		
1)Crompton Greaves Limited., 6th Floor, Cg House, Dr Annie Besant Road, Worli, Mumbai-400 030, Maharashtra, India.			
Date of Registration	18/03/2009		
Title	Lighting Fixture		
Priority NA			
Design Number	221772		
Class	06-11		
1)William Goodacre & Sons India Pvt. Ltd., XVIII/1146 Revi Karunakarm Road, Alleppey, Kerala-688012, India			
Date of Registration	19/03/2009		
Title	Mat		
Priority NA			
Design Number	221802		
Class	23-04		
1)Reckitt Benckiser (Uk) Limited., 103-105 Bath Road, Slough, Berkshire, SL1 3uh, Uk.			
Date of Registration	20/03/2009		
Title	Air Freshner Device		
Priority			
Priority Number	Date	Country	
001011381-0001	30/09/2008	EUROPEAN UNION	

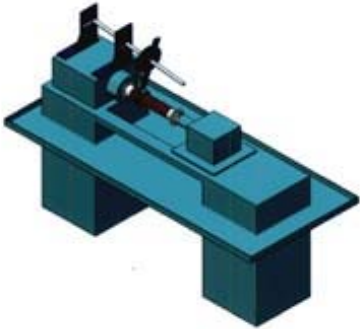

Design Number	221805	
Class	23-04	
1)Crompton Greaves Limited., 6th Floor, Cg House, Dr Annie Besant Road, Worli, Mumbai-400 030, Maharashtra, India.		
Date of Registration	20/03/2009	
Title	Ceiling Fan	
Priority NA		

Design Number	221809	
Class	23-04	
1)Crompton Greaves Limited., 6th Floor, Cg House, Dr Annie Besant Road, Worli, Mumbai-400 030, Maharashtra, India.		
Date of Registration	20/03/2009	
Title	Ceiling Fan	
Priority NA		

Design Number	221851	
Class	23-04	
1)Crompton Greaves Limited., 6th Floor, Cg House, Dr Annie Besant Road, Worli, Mumbai-400 030, Maharashtra, India.		
Date of Registration	23/03/2009	
Title	Ceiling Fan	
Priority NA		

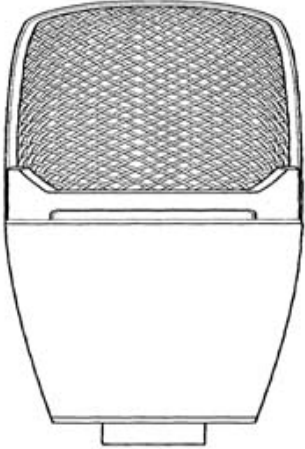
Design Number	221883	
Class	21-02	
1)Taneja Kaushal Omprakash., Ground Floor,74/77,Shree Krishna Center, Nr. Lift, Opp.Amabaji Mataji Temple, Nr. Mithakhali Six Cross Road, Mithakhali, Navrangpura, Ahmed.-380009.		
Date of Registration	24/03/2009	
Title	Massager Device	
Priority NA		
Design Number	221914	
Class	08-08	
1)Crompton Greaves Limited., 6th Floor, Cg House, Dr Annie Besant Road, Worli, Mumbai-400 030, Maharashtra, India.		
Date of Registration	24/03/2009	
Title	Coil Winding Fixture	
Priority NA		
Design Number	221928	
Class	13-99	
1)Crompton Greaves Limited., 6th Floor, Cg House, Dr Annie Besant Road, Worli, Mumbai-400 030, Maharashtra, India.		
Date of Registration	25/03/2009	
Title	Device for Disassembling the stator and rotor of a motor	
Priority NA		

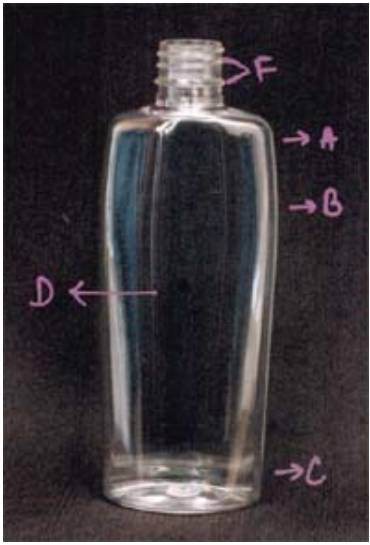
Design Number	221933	
Class	10-04	
1)Crompton Greaves Limited., 6th Floor, Cg House, Dr Annie Besant Road, Worli, Mumbai-400 030, Maharashtra, India.		
Date of Registration	25/03/2009	
Title	Oil Level Indicator	
Priority NA		
Design Number	221980	
Class	06-02	
1)Godrej & Boyce Mfg. Co. Ltd., Pirojshanagar, Vikhroli, Mumbai-400 079, Maharashtra, India.		
Date of Registration	26/03/2009	
Title	Fowler Bed	
Priority NA		
Design Number	221992	
Class	14-03	
1)Shure Acquisitions Holdings Inc., 5800 West Touhy Avenue, Niles, Illinois 60714, Usa.		
Date of Registration	27/03/2009	
Title	Microphone	
Priority NA		

Design Number	219827	
Class	09-01	
1)Varahi Private Limited WZ-8/1, Industrial Area, Kirti Nagar, New Delhi-110015, India		
Date of Registration	21/11/2008	
Title	Bottle	
Priority NA		
Design Number	219828	
Class	09-01	
1)Varahi Private Limited WZ-8/1, Industrial Area, Kirti Nagar, New Delhi-110015, India		
Date of Registration	21/11/2008	
Title	Bottle	
Priority NA		
Design Number	219875	
Class	30-03	
1)M/s. Ganpati Poultry Equipments 14/27B, Dr. H.K. Chatterjee Lane, Ghosuri, Howrah-711107, West Bengal, India		
Date of Registration	26/11/2008	
Title	Tray	
Priority NA		

Design Number	219876	
Class	30-03	
1)Ganpati Poultry Equipments 14/27B, Dr. H.K. Chatterjee Lane, Ghosuri, Howrah-711107, West Bengal, India		
Date of Registration	26/11/2008	
Title	Drinking & Feeder Stand	
Priority NA		

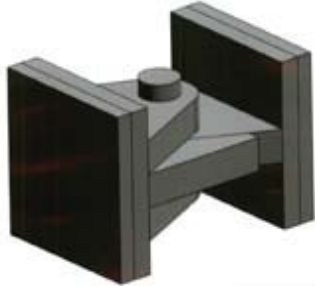
Design Number	222053	
Class	08-99	
1)Crompton Greaves Limited., 6th Floor, Cg House, Dr Annie Besant Road, Worli, Mumbai-400 030, Maharashtra, India.		
Date of Registration	30/03/2009	
Title	Damper for Switchgear Assembly	
Priority NA		

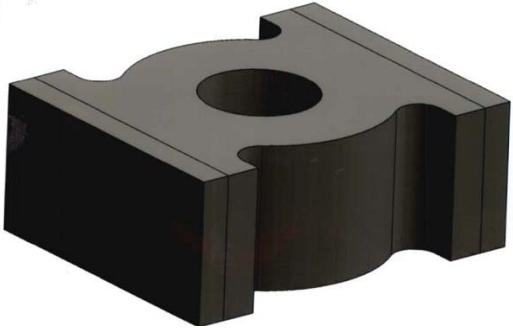
Design Number	222062	
Class	08-99	
1)Crompton Greaves Limited., 6th Floor, Cg House, Dr Annie Besant Road, Worli, Mumbai-400 030, Maharashtra, India.		
Date of Registration	30/03/2009	
Title	Damper for Switchgear Assembly	
Priority NA		

Design Number	222065	
Class	08-99	
1)Crompton Greaves Limited., 6th Floor, Cg House, Dr Annie Besant Road, Worli, Mumbai-400 030, Maharashtra, India.		
Date of Registration	30/03/2009	
Title	Damper for Switchgear Assembly	
Priority NA		

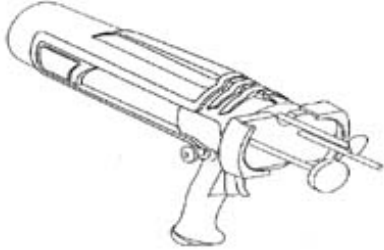
Design Number	222087		
Class	08-05		
1)3m Innovative Properties Company., 3m Center, Saint Paul, Minnesota 55133-3427, Usa.			
Date of Registration	30/03/2009		
Title	Dual Chamber Mixing Gun		
Priority			
Priority Number	Date	Country	
29/325,463	01/10/2008	U.S.A.	

Design Number	222094		
Class	23-04		
1)Crompton Greaves Limited., 6th Floor, Cg House, Dr Annie Besant Road, Worli, Mumbai-400 030, Maharashtra, India.			
Date of Registration	30/03/2009		
Title	Ceiling Fan		
Priority NA			

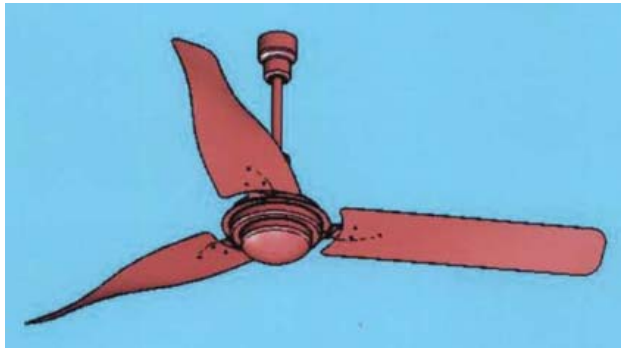
Design Number	222099	
Class	23-04	
1)Crompton Greaves Limited., 6th Floor, Cg House, Dr Annie Besant Road, Worli, Mumbai-400 030, Maharashtra, India.		
Date of Registration	30/03/2009	
Title	Ceiling Fan	
Priority NA		

Design Number	222113	
Class	09-01	
1)Elder Health Care Limited., Elder House, Plot No. C-9, Dalia Industrial Estate, Off. Veera Desai Road, Andheri (West), Mumbai-400 053, Maharashtra, India.		
Date of Registration	30/03/2009	
Title	Bottle	
Priority NA		

Design Number	222128	
Class	13-99	
1)Crompton Greaves Limited., 6th Floor, Cg House, Dr Annie Besant Road, Worli, Mumbai-400 030, Maharashtra, India.		
Date of Registration	31/03/2009	
Title	Electric Holder	
Priority NA		

Design Number	222217
Class	26-03
1)Crompton Greaves Limited., 6th Floor, Cg House, Dr Annie Besant Road, Worli, Mumbai-400 030, Maharashtra, India.	
Date of Registration	31/03/2009
Title	Lighting Fixture
Priority NA	

