

CONTINUED FROM PART- 1

INTRODUCTION



In view of the recent amendment made in the Designs (Amendment) Rules, 2008 with effect from 17/06/2008, Publication of the matter relating to Designs is being published in the Official Journal of The Patent Office. This Journal is being published on weekly basis on every Friday covering the various proceedings on Designs as required according to the provisions of under Rule 22, 25, 27 and 39 of the Design (Amendment) Rules, 2008. All the enquiries on this Official Journal and other information as required by the public should be addressed to the Controller General of Patents, Designs & Trade Marks. Suggestions and comments are requested from all quarters so that the content can be enriched.

REGISTRATION OF DESIGNS

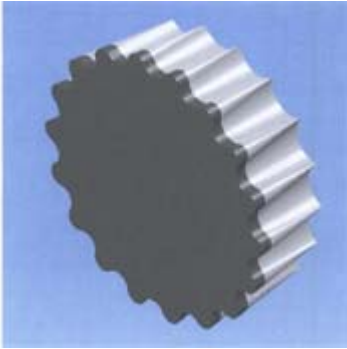
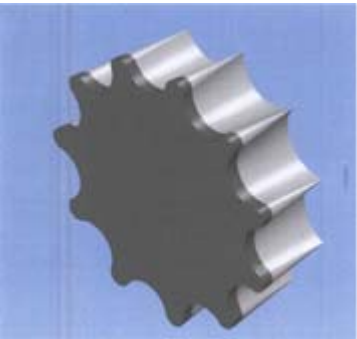

The following designs have been registered. They are now open for public inspection. In the following each entry the Date of Registration is shown. The Priority Number, Priority Date and Priority Country are also shown

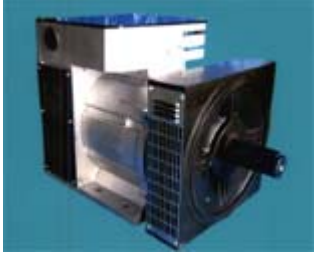
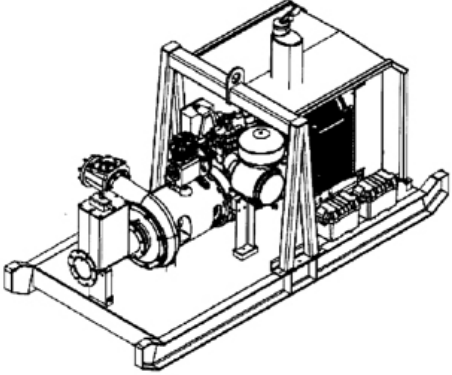
Design Number	213286	
Class	04-02	
1)JATIN VASANT THAKKAR., L-3/4, EDEN HALL, DR. ANNIE BESANT ROAD, WORLI, MUMBAI-400 018, MAHARASHTRA, INDIA.		
Date of Registration	05/11/2007	
Title	Tooth Brush	
Priority NA		
Design Number	216197	
Class	09-03	
1)DEVENDER KUMAR GUPTA., 99 KAPIL VIHAR, PITAMPURA, DELHI, INDIA.		
Date of Registration	05/05/2008	
Title	Container	
Priority NA		
Design Number	216311	
Class	02-01	
1)SRI SHYAMJI RASTOGL., CK-60/28, KARNA GHANTA, VARANASI, UP, INDIA.		
Date of Registration	14/05/2008	
Title	Undergarments	
Priority NA		

Design Number	216324	
Class	07-01	
1)ARUSH BALUJA., 15/78, SUBHASH NAGAR, NEWDELHI-110 027, INDIA.		
Date of Registration	14/05/2008	
Title	Coffee Set	
Priority NA		
Design Number	221702	
Class	08-03	
1)Tata Motors Limited., Bombay House, 24 Homi Mody Street, Hutatma Chowk, Mumbai-400 001, Maharashtra, India.		
Date of Registration	16/03/2009	
Title	Multi-Edge Metal Cutting Composite Insert	
Priority NA		
Design Number	221705	
Class	08-03	
1)Tata Motors Limited., Bombay House, 24 Homi Mody Street, Hutatma Chowk, Mumbai-400 001, Maharashtra, India.		
Date of Registration	16/03/2009	
Title	Multi-Edge Metal Cutting Composite Insert	
Priority NA		

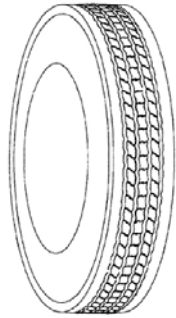
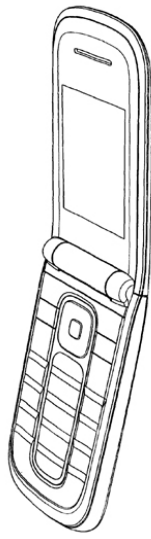
Design Number	221721		
Class	13-01		
1)Crompton Greaves Limited., 6th Floor, C.G. House, Dr. Annie Besant Road, Worli, Mumbai-400 030, Maharashtra, India.			
Date of Registration	17/03/2009		
Title	Alternator		
Priority NA			
Design Number	221832		
Class	15-02		
1)Weir Minerals Australia Ltd., 1 Marden Street, Artarmon, New South Wales 2064, Australia.			
Date of Registration	20/03/2009		
Title	Mine Dewatering Apparatus		
Priority			
Priority Number	Date	Country	
14528/2008	22/09/2008	Australia	
Design Number	221850		
Class	23-04		
1)Crompton Greaves Limited., 6th Floor, C.G. House, Dr. Annie Besant Road, Worli, Mumbai-400 030, Maharashtra, India.			
Date of Registration	23/03/2009		
Title	Ceiling Fan		
Priority NA			

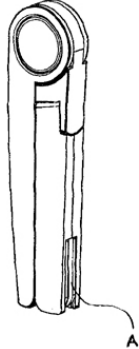
Design Number	214388	
Class	09-03	
1)JAI SHRI KANT WADHWA, PLOT NO. C-52, INDUSTRIAL FOCAL POINT, NABHA, DISTT. PATIALA, PUNJAB, INDIA.		
Date of Registration	23/01/2008	
Title	Jar	
Priority NA		
		
Design Number	219870	
Class	12-15	
1)Bridgestone Corporation 10-1, Kyobashi 1-chome, Chuo-ku, Tokyo 104-8340, Japan		
Date of Registration	26/11/2008	
Title	Tire Tread	
Priority NA		
		
Design Number	219961	
Class	14-03	
1)Nokia Corporation Keilalahdentie, 4, Fin-02150, Espoo, Finland.		
Date of Registration	01/12/2008	
Title	Handset	
Priority		
Priority Number	Date	Country
29/324, 226	09/09/2008	U.S.A.
		

Design Number	212819		
Class	14-99		
1)Innovative Office Products, Inc., 100 Keubler Road, Easton, Pennsylvania 18040, Usa.			
Date of Registration	08/10/2007		
Title	Stand		
Priority			
Priority Number	Date	Country	
29/286,166	25/04/2007	U.S.A.	
Design Number	221047		
Class	23-02		
1)HSIL Limited, Bahadurgarh-124507, Dist. Jhajjar, Haryana, India.			
Date of Registration	02/02/2009		
Title	Wall Mounted European Water Closet		
Priority NA			
Design Number	221049		
Class	26-05		
1)Ge India Industrial Pvt. Ltd., Plot No. 42/1, & 45/14, Electronic City Phase 11, Bangalore-560100, Karnataka, India.			
Date of Registration	02/02/2009		
Title	Well-Glass Luminaire		
Priority NA			

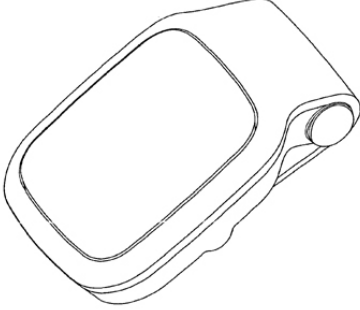
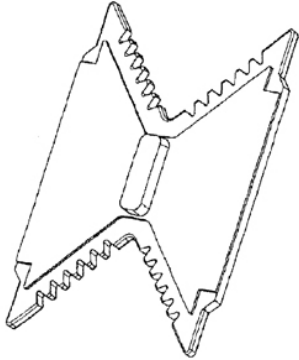
Design Number	221118		
Class	26-02		
1)Crompton Greaves Limited., 6th Floor, C.g. House, Dr. Annie Besant Road, Worli, Mumbai-400 030, Maharashtra, India.			
Date of Registration	09/02/2009		
Title	Solar Lantern		
Priority NA			
Design Number	221203		
Class	14-03		
1)Nokia Corporation Keilalahdentie 4, Fin-02150 Espoo, Finland.			
Date of Registration	13/02/2009		
Title	Wireless Receiver		
Priority			
Priority Number	Date	Country	
29/332,270	12/02/2009	U.S.A.	
Design Number	218037		
Class	15-99		
1)United States Gypsum Company 550 West Adams Street Chicago, Illinois 60661-3676 United States of America			
Date of Registration	22/08/2008		
Title	Inside Corner Gate of a Reservoir for use in Applying joint Compound to Paper Beads		
Priority			
Priority Number	Date	Country	
29/304, 087	25/02/2008	U.S.A.	

Design Number	218040	
Class	15-99	
1)United States Gypsum Company 550 West Adams Street Chicago, Illinois 60661-3676 United States of America		
Date of Registration	22/08/2008	
Title	Outside Corner Gate of a Reservoir for Use in Applying Joint Compound to Paper Beads	
Priority		
Priority Number	Date	Country
29/304,090	25/02/2008	U.S.A.

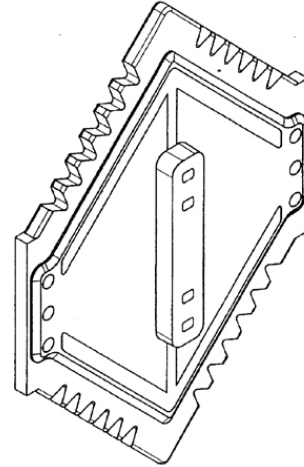

Design Number	221853	
Class	23-04	
1)Crompton Greaves Limited., 6th Floor, C.G. House, Dr. Annie Besant Road, Worli, Mumbai-400 030, Maharashtra, India.		
Date of Registration	23/03/2009	
Title	Ceiling Fan	
Priority NA		

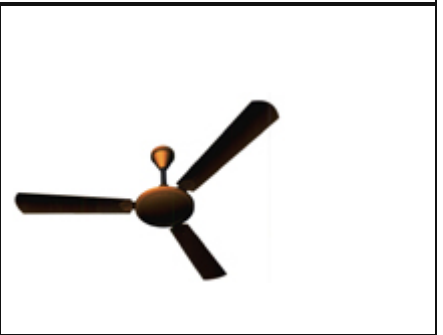

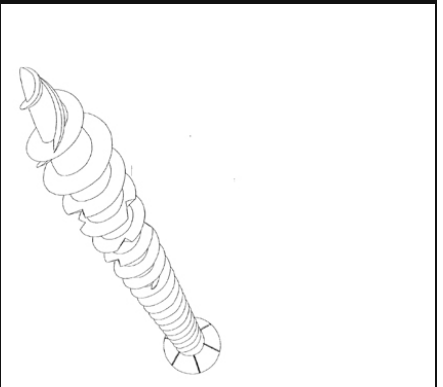

Design Number	221919	
Class	08-08	
1)Fischerwerke Gmbh & Co. Kg., Weinhalde 14-18, 72178 Waldachtal, Germany.		
Date of Registration	25/03/2009	
Title	Screw	
Priority		
Priority Number	Date	Country
001010508	29/09/2008	OHIM



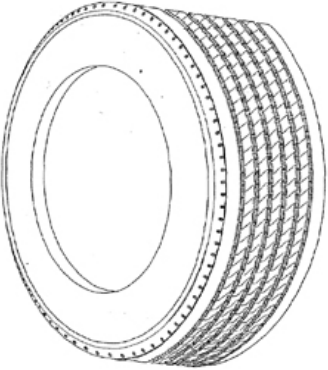
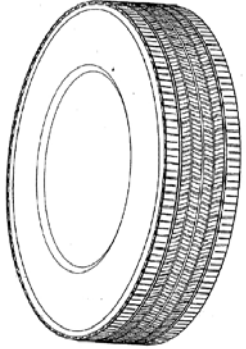



Design Number	221925	
Class	13-01	
1)Crompton Greaves Limited., 6th Floor, C.G. House, Dr. Annie Besant Road, Worli, Mumbai-400 030, Maharashtra, India.		
Date of Registration	25/03/2009	
Title	Motor	
Priority NA		
Design Number	221935	
Class	23-02	
1)S. ILANGO VAN AND PROF. (DR.) S.K.NAYAK ., CIPET, TVK INDUSTRIAL AREA, GUINDY, CHENNAI-600032, TN, INDIA.		
Date of Registration	25/03/2009	
Title	Wash Basin	
Priority NA		
Design Number	221936	
Class	03-01	
1)S. ILANGO VAN AND PROF. (DR.) S.K.NAYAK ., CIPET, TVK INDUSTRIAL AREA, GUINDY, CHENNAI-600032, TN, INDIA.		
Date of Registration	25/03/2009	
Title	Cosmetic Box	
Priority NA		

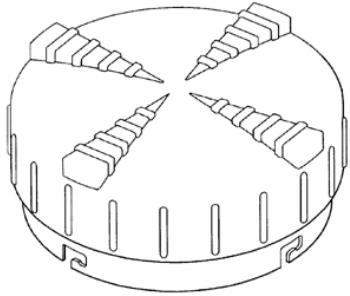

Design Number	221974		
Class	28-02		
1)Hindustan Unilever Limited., Hindustan Lever House 165-166 Backbay Reclamation, Mumbai-400 020, Maharashtra, India.			
Date of Registration	26/03/2009		
Title	Soap Bar		
Priority NA			
Design Number	221997		
Class	12-15		
1)Michelin Recherche Et Technique S.A., And Societe De Technologie Michelin., Route Louis-Braille 10, Ch-1763, Granges-Paccot, Switzerland. And 23 Rue Breschet, Fr-63000, Clermont-Ferrand, France.			
Date of Registration	27/03/2009		
Title	Tyre		
Priority			
Priority Number	Date	Country	
29/326,043	10/10/2008	U.S.A.	
Design Number	221998		
Class	12-15		
1)Michelin Recherche Et Technique S.A., Route Louis-Braille 10, Ch-1763, Granges-Paccot, Switzerland.			
Date of Registration	27/03/2009		
Title	Tyre		
Priority			
Priority Number	Date	Country	
15139/2008	28/10/2008	Australia	

Design Number	211436	
Class	06-05	
1)MR. LALIT HIRANANDANI D-23 INDRASUKH SOCIETY, FOUR BUNGALOWS, ANDHERI (WEST), MUMBAI-400052, MAHARASHTRA, INDIA.		
Date of Registration	30/07/2007	
Title	Multifunctional Seating Called As Ybut	
Priority NA		

Design Number	217200	
Class	07-02	
1)AVINASIAPPAN SUDARSAN., # G-9, VYASARPADI INDUSTRIAL ESTATE, VYASARPADI, CHENNAI- 600 039, TAMIL NADU, INDIA.		
Date of Registration	17/07/2008	
Title	Pressure Cooker	
Priority NA		

Design Number	219419		
Class	13-03		
1)Littelfuse, Inc., 800 East Northwest Highway, Des Plaines, Illinois 60016, U.S.A.			
Date of Registration	23/10/2008		
Title	Vehicle Electrical Center Cover		
Priority			
Priority Number	Date	Country	
29/317,165	23/04/2008	U.S.A.	

Design Number	219421		
Class	28-03		
1)S. B. International 413-414, Imperial Towers, C-Block Community Center, Naraina Vihar, New Delhi-110028, India			
Date of Registration	23/10/2008		
Title	Mixing Spatula		
Priority NA			
Design Number	219591		
Class	11-01		
1)De Beers Centenary AG., Alpenstrasse 5, 6000 Luzern 6, Switzerland			
Date of Registration	07/11/2008		
Title	Bracelet		
Priority			
Priority Number	Date	Country	
000963673	02/07/2008	OHIM	
Design Number	221229		
Class	05-05		
1)Charming Apparels (P) Ltd., 402-405, 1st Floor, Main Road, Chandni Chowk, Delhi-110 006, India.			
Date of Registration	16/02/2009		
Title	Textile Fabric		
Priority NA			



Design Number	221232	
Class	05-05	
1)Charming Apparels (P) Ltd., 402-405, 1st Floor, Main Road, Chandni Chowk, Delhi-110 006, India.		
Date of Registration	16/02/2009	
Title	Textile Fabric	
Priority NA		
Design Number	221235	
Class	05-05	
1)Charming Apparels (P) Ltd., 402-405, 1st Floor, Main Road, Chandni Chowk, Delhi-110 006, India.		
Date of Registration	16/02/2009	
Title	Textile Fabric	
Priority NA		
Design Number	221246	
Class	23-02	
1)Hindustan Sanitaryware & Industries Limited., Bahadurgarh-124507, Haryana, India.		
Date of Registration	16/02/2009	
Title	Cistern	
Priority NA		

Design Number	221283	
Class	06-09	
1)MR. CHINNAPPA GOUNDER THANGARAJ, MRS. CHINNAPPA GOUNDER ARUKKANI AMMAL & MRS. THANGARAJ HARIPRIYA., SF 150/B, SANJAY NAGAR, ERODE MAIN ROAD, KARUR-639 002, TN, INDIA.		
Date of Registration	18/02/2009	
Title	SEAT Cushion	
Priority NA		
Design Number	221284	
Class	06-09	
1)MR. CHINNAPPA GOUNDER THANGARAJ, MRS. CHINNAPPA GOUNDER ARUKKANI AMMAL & MRS. THANGARAJ HARIPRIYA., SF 150/B, SANJAY NAGAR, ERODE MAIN ROAD, KARUR-639 002, TN, INDIA.		
Date of Registration	18/02/2009	
Title	Seat Cushion	
Priority NA		
Design Number	221329	
Class	02-04	
1)Liberty Shoes Limited., Liberty Puram, 13, Milestone, Gt Karnal Road, Kutail, Dt-Karnal-132001, Haryana, India.		
Date of Registration	20/02/2009	
Title	Sole For Footwear	
Priority NA		

Design Number	211054	
Class	02-04	
1)SHABEER ALI PATHOOR PATHOOR HOUSE, KODINHI P.O. TIRURANGADI (VIA), MALAPPURAM DISTRICT, KERALA, PIN-676309, INDIA.		
Date of Registration	06/07/2007	
Title	Footwear	
Priority NA		
Design Number	213549	
Class	11-01	
1)SANJAY SHAH., 13, ARYAVARTA, NARAYAN DABHOLKAR ROAD, MUMBAI-400 006, INDIA.		
Date of Registration	28/11/2007	
Title	Gemstone	
Priority NA		
Design Number	213550	
Class	11-01	
1)SANJAY SHAH., 13, ARYAVARTA, NARAYAN DABHOLKAR ROAD, MUMBAI-400 006, INDIA.		
Date of Registration	28/11/2007	
Title	Gemstone	
Priority NA		

Design Number	213767		
Class	15-06		
1)BHARAT BHUSHAN GUPTA., 21/4, SHAKTI NAGAR, DELHI-110 007, INDIA.			
Date of Registration	17/12/2007		
Title	Portable Sewing Machine		
Priority NA			
Design Number	216390		
Class	12-16		
1)Honeywell International Inc. 101 Columbia Road, P.O. Box 2245, Morristown, New Jersey 07962-2245, U.S.A.			
Date of Registration	21/11/2007		
Title	All Terrain Vehicles Right-Hand Handle Bar Controller		
Priority			
Priority Number	Date	Country	
29/293,433	21/11/2007	U.S.A.	
Design Number	216391		
Class	12-16		
1)Honeywell International Inc. 101 Columbia Road, P.O. Box 2245, Morristown, New Jersey 07962-2245, U.S.A.			
Date of Registration	21/05/2008		
Title	All Terrain Vehicles Left-Hand Handle Bar Controller		
Priority			
Priority Number	Date	Country	
29/293,434	21/11/2007	U.S.A.	
			

Design Number	216407		
Class	04-02		
1)Cholayil Private Limited., Cholayil, No. 8, J-Block, 6th Avenue, Anna Nagar, Chennai-600 102, Tn, India.			
Date of Registration	23/05/2008		
Title	Body Scrubber		
Priority NA			
Design Number	218948		
Class	10-05		
1)Festo Ag & Co.Kg Ruiter Strasse 82, D-73734 Esslingen, Germany			
Date of Registration	03/10/2008		
Title	Detector For Detecting The Angular Position Of A Rotatable Shaft		
Priority			
Priority Number	Date	Country	
000 910 187-0003	07/04/2008	OHIM	
Design Number	220651		
Class	17-01		
1)MOON SI, YEON., 42-303 SHINBANPO 15TH APT., 12 BANPO-DONG, SEOCHO-GU, SEOUL, JAPAN.			
Date of Registration	01/01/2009		
Title	Keys of Electric Keyboard		
Priority NA			

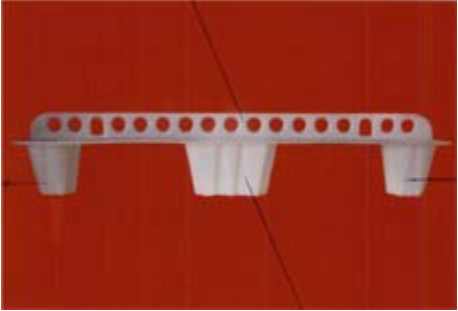
Design Number	220715	
Class	30-03	
1)SHRI MUNIT KUMAR & SHRI DEVINDER KUMAR., A-98/1, WAZIRPUR INDUSTRIAL AREA, DELHI-110052, INDIA.		
Date of Registration	07/01/2009	
Title	BOWL FOR DOG FEEDING	
Priority NA		
Design Number	220740	
Class	08-06	
1)Euro India, 5/500, Shakti Nagar, Gular Road, Aligarh-202001, Up, India.		
Date of Registration	12/01/2009	
Title	Pull Handle	
Priority NA		
Design Number	220754	
Class	09-04	
1)MYLSAMY RANGA RAMANUJAM ., COATS, NO.-13/24, SITRA KALAPATTI ROAD, CIVIL AERODROME POST, COIMBATORE-641 014, TAMILNADU, INDIA.		
Date of Registration	13/01/2009	
Title	Hampers	
Priority NA		

Design Number	220789	
Class	12-16	
1)PROF. (DR.) S.K.NAYAK & N. DURAI, CENTRAL INSTITUTE OF PLASTICS ENGINEERING & TECHNOLOGY, TVK INDUSTRIAL AREA, GUINDY, CHENNAI-600032, TAMILNADU, INDIA.		
Date of Registration	15/01/2009	
Title	Radiator Cap	
Priority NA		
Design Number	220867	
Class	13-02	
1)Su-Kam Power Systems Ltd., Plot No. Wz-1401/2, Nangal Raya, New Delhi-110 046, India.		
Date of Registration	20/01/2009	
Title	Battery Tray	
Priority NA		
Design Number	209237	
Class	03-99	
1)CROMPTON GREAVES LIMITED 6th Floor, CG House, Dr. Annie Besant Road, Worli,		
Date of Registration	30/03/2007	
Title	METAL CASTING FOR CIRCUIT BREAKER	
Priority NA		

Design Number	215089		
Class	02-02		
1)KAIZAR MITHAIWALA AND RADHIKA NAIK., NO. 6, SEA VIEW TERRACE, 68-71 WODEHOUSE ROAD, COLABA, MUMBAI-400 005, INDIA,			
Date of Registration	03/03/2008		
Title	Garment		
Priority NA			
Design Number	215208		
Class	06-06		
1)HAKIM KHURSHID., DEVLILA APARTMENTS, SHOP NO. 8, FATEMA NAGAR, PUNE-411 013, MAHARASHTRA, INDIA.			
Date of Registration	11/03/2008		
Title	Profile		
Priority NA			
Design Number	220208		
Class	11-01		
1)Preciosa, a.s., Opletalova 3197, 466 67 Jablonec nad Nisou, Czech Republic			
Date of Registration	15/12/2008		
Title	Gemstone		
Priority			
Priority Number	Date	Country	
EM 000952544-0020	17/06/2008	OHIM	

Design Number	220210	
Class	11-01	
1)Preciosa, a.s., Opletalova 3197, 466 67 Jablonec nad Nisou, Czech Republic		
Date of Registration	15/12/2008	
Title	Gemstone	
Priority		
Priority Number	Date	Country
EM 000952544-0043	17/06/2008	OHIM

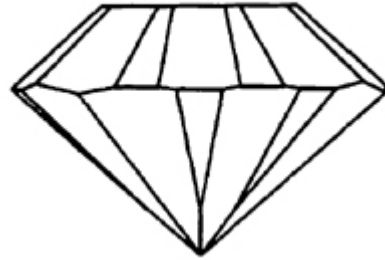

Design Number	220375	
Class	08-06	
1)Pnl Metalware Pvt Ltd., G-1843, Kishan Gate Road, G.I.D.C. Metoda (Lodhika), Taluka: Lodhika, Dist.: Rajkot-360021. Gujarat, India		
Date of Registration	22/12/2008	
Title	Door Handle	
Priority NA		



Design Number	211947	
Class	11-01	
1)PUNITA TRRIKHA S-69, GREATER KAILASH, PART-1, NEW DELHI-110048, INDIA.		
Date of Registration	20/08/2007	
Title	Cuff Link	
Priority NA		



Design Number	217722	
Class	08-06	
1) Dolphin Hardware Industries Plot No. C-1-B, 236/5, Aji G.I.D.C., Near Cargo Motor's, Rajkot-360003, Gujarat, India		
Date of Registration	13/08/2008	
Title	Knob	
Priority NA		