

CONTINUED FROM PART- 1

INTRODUCTION

In view of the recent amendment made in the Designs (Amendment) Rules, 2008 with effect from 17/06/2008, Publication of the matter relating to Designs is being published in the Official Journal of The Patent Office. This Journal is being published on weekly basis on every Friday covering the various proceedings on Designs as required according to the provisions of under Rule 22, 25, 27 and 39 of the Design (Amendment) Rules, 2008. All the enquiries on this Official Journal and other information as required by the public should be addressed to the Controller General of Patents, Designs & Trade Marks. Suggestions and comments are requested from all quarters so that the content can be enriched.

CANCELLATION PROCEEDINGS
under Section 19 of the Designs Act, 2000

“The Ld. Asstt. Controller of Patents & Designs passed an order on 14/9/2010 to dismiss the petition filed by M/s. S.N. Kapoor Exports, Khawasji Ka Bagh, Amer Road, Jaipur-302002 on 27/12/2006 for cancellation of registration of the registered Design No. 193828 dated 20/11/2003 under class 06-11 titled as ‘Carpet’ in the name of Mahesh Kumar Choudhary & Basu Devi Choudhary, both Indian partners, trading as M/s. Saraswati Exports, an Indian partnership firm of 3 Ganesh Colony, behind Golimar Garden, Amer Road, Jaipur-302002, Rajasthan, India.”

“The Ld. Asstt. Controller of Patents & Designs passed an order on 14/9/2010 to dismiss the petition filed by M/s. S.N. Kapoor Exports, Khawasji Ka Bagh, Amer Road, Jaipur-302002 on 27/12/2006 for cancellation of registration of the registered Design No. 193831 dated 20/11/2003 under class 06-11 titled as ‘Carpet’ in the name of Mahesh Kumar Choudhary & Basu Devi Choudhary, both Indian partners, trading as M/s. Saraswati Exports, an Indian partnership firm of 3 Ganesh Colony, behind Golimar Garden, Amer Road, Jaipur-302002, Rajasthan, India.”



“The Ld. Asstt. Controller of Patents & Designs passed an order on 14/9/2010 to dismiss the petition filed by M/s. S.N. Kapoor Exports, Khawasji Ka Bagh, Amer Road, Jaipur-302002 on 27/12/2006 for cancellation of registration of the registered Design No. 193832 dated 20/11/2003 under class 06-11 titled as ‘Carpet’ in the name of Mahesh Kumar Choudhary & Basu Devi Choudhary, both Indian partners, trading as M/s. Saraswati Exports, an Indian partnership firm of 3 Ganesh Colony, behind Golimar Garden, Amer Road, Jaipur-302002, Rajasthan, India.”



“The Ld. Asstt. Controller of Patents & Designs passed an order on 14/9/2010 to dismiss the petition filed by M/s. S.N. Kapoor Exports, Khawasji Ka Bagh, Amer Road, Jaipur-302002 on 12/4/2006 for cancellation of registration of the registered Design No. 194335 dated 23/1/2004 under class 06-11 titled as ‘Carpet’ in the name of Mahesh Kumar Choudhary & Basu Devi Choudhary, both Indian partners, trading as Saraswati Exports, an Indian partnership firm of 3 Ganesh Colony, behind Golimar Garden, Amer Road, Jaipur-302002, Rajasthan, India.”

“The Ld. Asstt. Controller of Patents & Designs passed an order on 14/9/2010 to dismiss the petition filed by M/s. S.N. Kapoor Exports, Khawasji Ka Bagh, Amer Road, Jaipur-302002 on 12/4/2006 for cancellation of registration of the registered Design No. 194337 dated 23/1/2004 under class 06-11 titled as ‘Carpet’ in the name of Mahesh Kumar Choudhary & Basu Devi Choudhary, both Indian partners, trading as Saraswati Exports, an Indian partnership firm of 3 Ganesh Colony, behind Golimar Garden, Amer Road, Jaipur-302002, Rajasthan, India.”

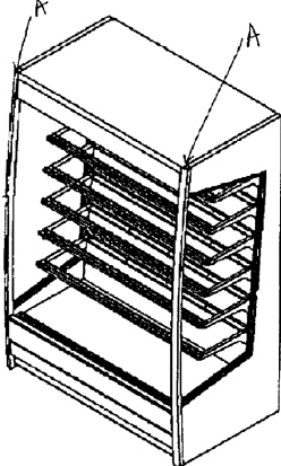
REGISTRATION OF DESIGNS

The following designs have been registered. They are now open for public inspection. In the following each entry the Date of Registration is shown. The Priority Number, Priority Date and Priority Country are also shown

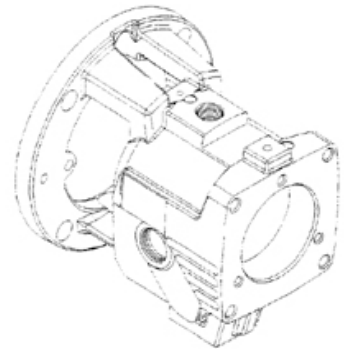

Design Number	213296	
Class	02-03	
1)Datt Enterprises., A-106, Mangol Puri Industrial Area, Phase-II, Delhi-110 085, India.		
Date of Registration	05/11/2007	
Title	Helmet	
Priority NA		
Design Number	213337	
Class	15-07	
1)Sanyo Electric Co. Ltd., 5-5, Keihanondori 2-Chome, Moriguchi-Shi, Osaka 570-8677, Japan.		
Date of Registration	07/11/2007	
Title	Cold Storage Showcase	
Priority		
Priority Number	Date	
2007-014500	31/05/2007	Japan
Design Number	216080	
Class	12-05	
1)Standard Corporation (India) Limited, Standard Chowk, Barnala-148 101, Punjab, India.		
Date of Registration	29/04/2008	
Title	Crane	
Priority NA		

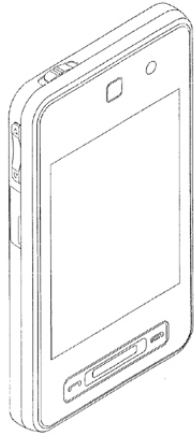
Design Number	216081		
Class	15-03		
1)Standard Corporation (India) Limited, Standard Chowk, Barnala-148 101, Punjab, India.			
Date of Registration	29/04/2008		
Title	Harvester Combine		
Priority NA			
Design Number	216194		
Class	15-99		
1)Itt Manufacturing Enterprises, Inc., 1105 N. Market Street, Suite 1217, Wilmington, Delaware 19801, Usa.			
Date of Registration	05/05/2008		
Title	Bearing Frame		
Priority			
Priority Number	Date	Country	
29/293,187	06/11/2007	U.S.A.	
Design Number	216195		
Class	23-04		
1)Sara Lee Household And Body Care Nederland B.V., Vleutensevaart 35 3532 Ad Utrecht, The Netherlands.			
Date of Registration	05/05/2008		
Title	Ari Deodorising Apparatus		
Priority			
Priority Number	Date	Country	
000896758	12/03/2008	OHIM	

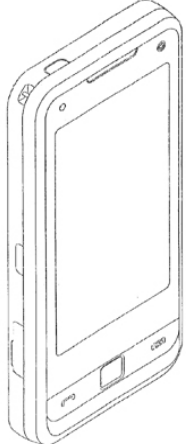

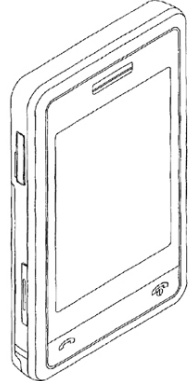
Design Number	216268	
Class	14-03	
1)Samsung Electronics Co. Ltd., 416, Maetan 3-Dong, Paldal-Gu, Suwon-City, Kyunggi-Do, Korea.		
Date of Registration	09/05/2008	
Title	Portable telephone	
Priority NA		

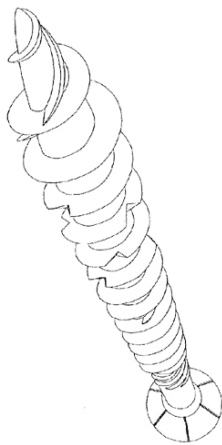

Design Number	216269	
Class	14-03	
1)Samsung Electronics Co. Ltd., 416, Maetan 3-Dong, Paldal-Gu, Suwon-City, Kyunggi-Do, Korea.		
Date of Registration	09/05/2008	
Title	Portable Telephone	
Priority NA		

Design Number	216270	
Class	14-03	
1)Samsung Electronics Co. Ltd., 416, Maetan 3-Dong, Paldal-Gu, Suwon-City, Kyunggi-Do, Korea.		
Date of Registration	09/05/2008	
Title	Portable Telephone	
Priority NA		



Design Number	218976		
Class	23-01		
1)Whirlpool S.A., Av. Das Nacoes Unidas, 12.995, 32° andar, Brooklin Novo, 04578-000, Sao Paulo, SP, Brazil			
Date of Registration	03/10/2008		
Title	Water Purifier		
Priority			
Priority Number	Date	Country	
DI6802355-3	17/06/2008	Brazil	
Design Number	219256		
Class	06-05		
1)Veneta Cucine S.P.A., Via Paris Bordone, 84, 31056 Roncade, Frazione Biancade (Prov. of Treviso), Italy			
Date of Registration	16/10/2008		
Title	Kitchen Furniture		
Priority			
Priority Number	Date	Country	
VE2008O000008	16/04/2008	Italy	
Design Number	221921		
Class	08-08		
1)Fischerwerke Gmbh & Co. Kg., Weinhalde 14-18, 72178 Waldachtal, Germany.			
Date of Registration	25/03/2009		
Title	Screw		
Priority			
Priority Number	Date	Country	
001010508	29/09/2008	OHIM	

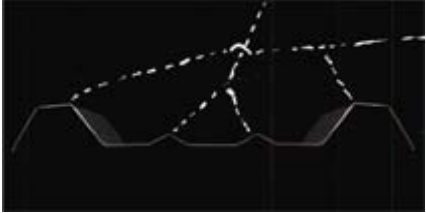

Design Number	222056		
Class	23-04		
1)Crompton Greaves Limited., 6th Floor, C. G. House, Dr Annie Besant Road, Worli, Mumbai-400 030, Maharashtra, India.			
Date of Registration	30/03/2009		
Title	Pedestal Fan		
Priority NA			
Design Number	215157		
Class	02-04		
1)New Balance Athletic Shoe, Inc., 20 Guest Street, Brighton, Ma 02135, Usa.			
Date of Registration	06/03/2008		
Title	Shoe Sole		
Priority			
Priority Number	Date	Country	
29/291,589	06/09/2007	U.S.A.	
Design Number	217573		
Class	02-04		
1)Anurag Footcare Pvt. Ltd., H-11, Udyog Nagar, Delhi-110041 (India)			
Date of Registration	06/08/2008		
Title	Sole For Footwear		
Priority NA			

Design Number	221233		
Class	05-05		
1)Charming Apparels (P) Ltd., 402-405, 1st Floor, Main Road, Chandni Chowk, Delhi-110 006, India.			
Date of Registration	16/02/2009		
Title	Textile Fabric		
Priority NA			
Design Number	221401		
Class	15-01		
1)Kubota Corporation., 2-47, Shikitsuhigashi 1-Chome, Naniwa-Ku, Osaka-Shi, Osaka 5568601, Japan.			
Date of Registration	25/02/2009		
Title	Internal Combustion Engine		
Priority			
Priority Number	Date	Country	
2008-021897	25/08/2008	Japan	
Design Number	221403		
Class	11-01		
1)Orogems., D-139, Defence Colony, New Delhi-110024, India.			
Date of Registration	25/02/2009		
Title	Bracelet		
Priority NA			

Design Number	213905	
Class	12-16	
1)Lovato Gas S.P.A., Strada Casale, 175-36100 Vicenza, Italy.		
Date of Registration	27/12/2007	
Title	Lpg Pressure Reducer	
Priority NA		
Design Number	213907	
Class	25-02	
1)Newscope Roofings Private Limited., No. 10, Kaliyamman Koil Street, Sree Sai Nagar, Virugambakkam, Chennai-600 092, India.		
Date of Registration	27/12/2007	
Title	Angular Roofing	
Priority NA		
Design Number	218365	
Class	07-02	
1)Hamilton Houseware Pvt. Ltd., Kaiser-I-Hind Bldg., 3rd Floor, Currimbhoy Road, Ballard Estate, Mumbai 400001, Maharashtra, India		
Date of Registration	04/09/2008	
Title	Container	
Priority NA		

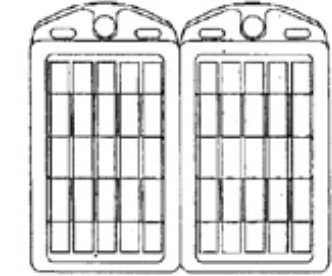
Design Number	218526		
Class	12-16		
1)Kubota Corporation, 2-47, Shikitsu Higashi 1-chome, Naniwa-ku, Osaka-shi, Osaka 5568601, Japan.			
Date of Registration	11/09/2008		
Title	Hood For Agricultural Machine		
Priority			
Priority Number	Date	Country	
2008-7838	28/03/2008	Japan	
Design Number	218530		
Class	15-03		
1)Kubota Corporation 2-47, Shikitsu Higashi 1-chome, Naniwa-ku, Osaka-shi, Osaka 5568601, Japan.			
Date of Registration	11/09/2008		
Title	Combine-Harvester		
Priority			
Priority Number	Date	Country	
2008-008024	31/03/2008	Japan	
Design Number	221711		
Class	09-03		
1)Nikita Containers Pvt. Ltd., F-7, Sipcot Industrial Complex, Irunkattukottai-602 105, Tamilnadu, India.			
Date of Registration	17/03/2009		
Title	CD or DVD Container		
Priority NA			

Design Number	221752		
Class	26-03		
1)Crompton Greaves Limited., 6th Floor, CG House, Dr. Annie Besant Road, Worli, Mumbai-400 030, Maharashtra, India.			
Date of Registration	18/03/2009		
Title	Bollard		
Priority NA			
Design Number	221759		
Class	09-01		
1)Hindustan Unilever Limited., Hindustan Lever House 165-166 Backbay Reclamation, Mumbai-400 020, Maharashtra, India.			
Date of Registration	18/03/2009		
Title	Bottle		
Priority NA			
Design Number	213781		
Class	09-03		
1)British American Tobacco (Investments) Limited Globe House, 1 Water Street, London, Wc2r3la, U.K.			
Date of Registration	17/12/2007		
Title	Cigarette Packet		
Priority			
Priority Number	Date	Country	
000745278	19/06/2007	OHIM	

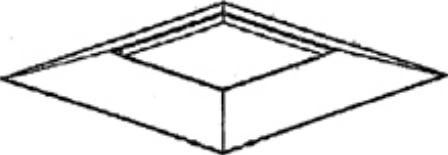
Design Number	216414		
Class	09-03		
1)Hisamitsu Pharmaceutical Co. Inc. 408, Tashirodaikan-Machi, Tosushi, Saga, 841-0017, Japan			
Date of Registration	26/05/2008		
Title	Packing Box		
Priority			
Priority Number	Date	Country	
2008-005301	04/03/2008	Japan	
Design Number	216416		
Class	09-03		
1)Hisamitsu Pharmaceutical Co. Inc. 408, Tashirodaikan-Machi, Tosushi, Saga, 841-0017, Japan			
Date of Registration	26/05/2008		
Title	Packing Box		
Priority			
Priority Number	Date	Country	
2008-005303	04/03/2008	Japan	
Design Number	216529		
Class	26-05		
1)Cree Led Lighting Solutions, Inc., 4600 Silicon Drive, Durham, Nc 27703.			
Date of Registration	02/06/2008		
Title	Lighting Device		
Priority			
Priority Number	Date	Country	
29/298,299	03/12/2007	U.S.A.	

Design Number	216539	
Class	14-03	
1)Nokia Corporation., Keilalahdentie 4, Fin-02150 Espoo, Finland.		
Date of Registration	03/06/2008	
Title	Handset	
Priority		
Priority Number	Date	Country
29/298,585	07/12/2007	U.S.A.

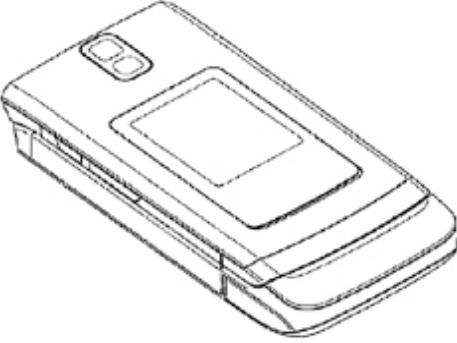



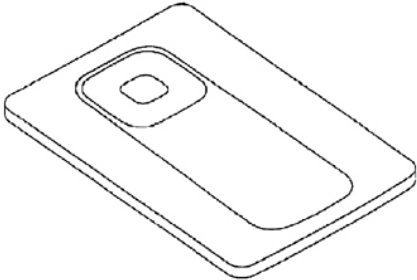

Design Number	216540	
Class	14-03	
1)Nokia Corporation., Keilalahdentie 4, Fin-02150 Espoo, Finland.		
Date of Registration	03/06/2008	
Title	Key Panel For A Handset	
Priority		
Priority Number	Date	Country
29/298,584	07/12/2007	U.S.A.

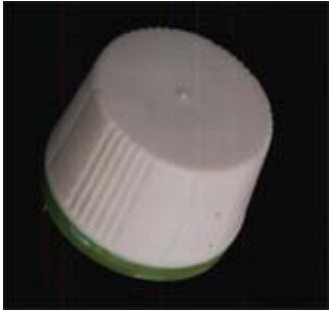
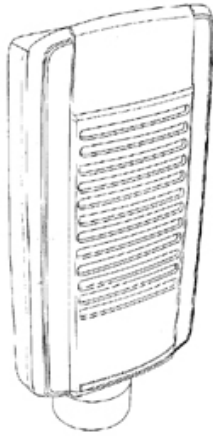
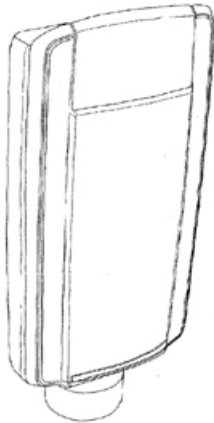

Design Number	216591	
Class	09-01	
1)MADHUKAR PRANLAL SANGANI, MANJULA MADHUKAR SANGANI, TUSHAR MADHUKAR SANGANI & NIRAV MADHUKAR SANGANI. 102, SONA UDYOG, PARSII PANCHAYAT ROAD, ANDHERI (EAST), MUMBAI-400 069, MAHARASHTRA, INDIA.		
Date of Registration	02/06/2008	
Title	Bottle	
Priority NA		



Design Number	216592		
Class	09-07		
1)Madhukar Pranolal Sangani, Manjula Madhukar Sangani, Tushar Madhukar Sangani & Nirav Madhukar Sangani. 102, Sona Udyog, Parsi Panchayat Road, Andheri (East), Mumbai-400 069, Maharashtra, India.			
Date of Registration	02/06/2008		
Title	Cap		
Priority NA			
Design Number	216595		
Class	16-01		
1)Axis Ab., Emdalavagen 14, Se-223 69 Lund, Sweden.			
Date of Registration	10/06/2008		
Title	Camera		
Priority			
Priority Number	Date	Country	
000860234	16/01/2008	OHIM	
Design Number	216596		
Class	16-01		
1)Axis AB Emdalavagen 14, SE-223 69 Lund, Sweden			
Date of Registration	10/06/2008		
Title	Camera		
Priority			
Priority Number	Date	Country	
000860234	16/01/2008	OHIM	

Design Number	216597		
Class	12-08		
1)Volvo Bus Corporation., 405 08 Goteborg, Sweden.			
Date of Registration	10/06/2008		
Title	Bus		
Priority			
Priority Number	Date	Country	
000870613-0001	31/01/2007	OHIM	
Design Number	216598		
Class	12-08		
1)Volvo Bus Corporation 405 08 Goteborg, Sweden			
Date of Registration	10/06/2008		
Title	Bus		
Priority			
Priority Number	Date	Country	
000870613-0002	31/01/2007	OHIM	
Design Number	216599		
Class	15-09		
1)Litmas, S.R.O. Krkonoska 149, 468 41 Tanvald, Czech Republic			
Date of Registration	10/06/2008		
Title	Re-Cementing Machines		
Priority			
Priority Number	Date	Country	
000844345-0001	18/12/2007	EUROPEAN UNION	

Design Number	216601	
Class	15-09	
1)Bobst SA Route Des Flumeaux 50, 1008 Prilly, Switzerland		
Date of Registration	11/06/2008	
Title	Platen Press with Cover	
Priority		
Priority Number	Date	Country
CH-134653	11/12/2007	Switzerland

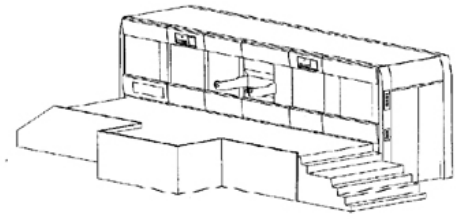







Design Number	216603	
Class	06-01	
1)Dedon Gmbh., Zeppelinstrasse 22, 21337, Luneburg, Germany.		
Date of Registration	12/06/2008	
Title	Chair	
Priority NA		



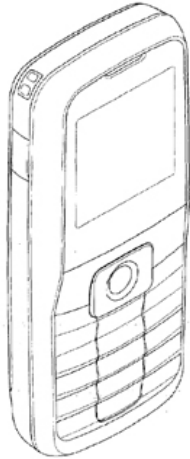

Design Number	216604	
Class	06-01	
1)Dedon Gmbh., Zeppelinstrasse 22, 21337, Luneburg, Germany.		
Date of Registration	12/06/2008	
Title	Chair	
Priority NA		





Design Number	216605		
Class	06-01		
1)Dedon Gmbh Zeppelinstrasse 22, 21337, Luneburg, Germany			
Date of Registration	12/06/2008		
Title	Lounge Chair		
Priority NA			
Design Number	214295		
Class	12-13		
1)Rasandik Engineering Industries India Ltd., C-4 & 5, First Floor, C-Block, Commercial Complex, Paschimi Marg, Vasant Vihar, New Delhi-110 057, India.			
Date of Registration	17/01/2008		
Title	Automobile		
Priority NA			
Design Number	216659		
Class	14-03		
1)Samsung Electronics Co., Ltd. 416, Maetan-Dong, Yeongtong-Gu, Suwon-Si, Gyeonggi-Do, Korea.			
Date of Registration	13/06/2008		
Title	Mobile Phone		
Priority			
Priority Number	Date	Country	
30-2008-0019119	07/05/2008	Republic of Korea	

Design Number	216660		
Class	14-03		
1)Samsung Electronics Co.Ltd 416 Metan-Dong, Yeongtong-Gu, Suwon-Si, Gyeonggi-Do, Korea			
Date of Registration	13/06/2008		
Title	Mobile Phone		
Priority			
Priority Number	Date	Country	
30-2008-0011798	19/03/2008	Korea(South)	
Design Number	216661		
Class	14-03		
1)Samsung Electronics Co.Ltd., 416, Metan-Dong, Yeongtong-Gu, Suwon-SI, Gyeonggi-Do, Republic of Korea.			
Date of Registration	13/06/2008		
Title	Mobile Phone		
Priority			
Priority Number	Date	Country	
30-2008-0011799	19/03/2008	Korea(South)	
Design Number	216686		
Class	07-02		
1)Sunflame Interprises Pvt. Ltd., 58, Sector, 27-C, Mathura Road, Faridabad-121003 (H.R.), India.			
Date of Registration	16/06/2008		
Title	Cooking Stove		
Priority NA			

Design Number	216763	
Class	07-06	
1)Ma Design India Private Limited, C-26, Sector-63, Noida, Up, Pin- 201301, India.		
Date of Registration	20/06/2008	
Title	Tray	
Priority NA		
Design Number	216770	
Class	07-01	
1)Ma Design India Private Limited, C-26, Sector-63, Noida, Up, India.		
Date of Registration	20/06/2008	
Title	Dish	
Priority NA		
Design Number	216774	
Class	07-01	
1)Ma Design India Private Limited., C-26, Sector-63, Noida, Up, Pin code: 201301, India.		
Date of Registration	20/06/2008	
Title	Lid	
Priority NA		

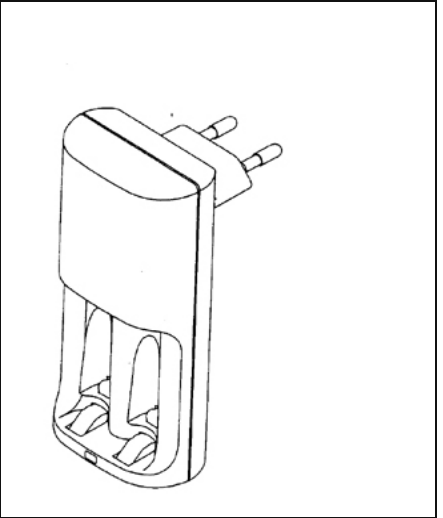
Design Number	220860	
Class	05-05	
1)Charming Apparels (P) Ltd., 402-405, 1st Floor, Main Road, Chandni Chowk, Delhi-110 006, India.		
Date of Registration	20/01/2009	
Title	Textile Fabric	
Priority NA		
Design Number	216961	
Class	13-02	
1)Sony Corporation., 1-7-1 Konan, Minato-Ku, Tokyo, Japan.		
Date of Registration	01/07/2008	
Title	Battery Charger	
Priority		
Priority Number	Date	Country
2008-014265	05/06/2008	Japan
Design Number	216963	
Class	02-04	
1)KHADIM INDIA LIMITED., KANKARIA ESTATE, 5TH FLOOR, 6, LITTLE RUSSELL STREET, KOLKATA-700 071, WB, INDIA.		
Date of Registration	01/07/2008	
Title	Footwear	
Priority NA		





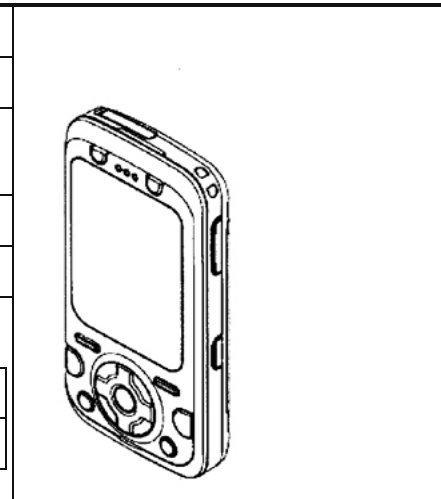

Design Number	216969	
Class	08-06	
1)PNL Metalware Pvt. Ltd., Plot No. G-1843, Kishan Gate Road, G.I.D.C.Metoda(Lodhika), Taluka, Lodhika, Dist.- Rajkot-360021, Gujarat, India.		
Date of Registration	02/07/2008	
Title	Door Handle	
Priority NA		

Design Number	217045	
Class	14-03	
1)Sony Ericsson Mobile Communications Ab., Se-221 88, Lund, Sweden.		
Date of Registration	08/07/2008	
Title	Mobile Phone	
Priority		
Priority Number	Date	Country
000867544-0002	28/01/2008	OHIM

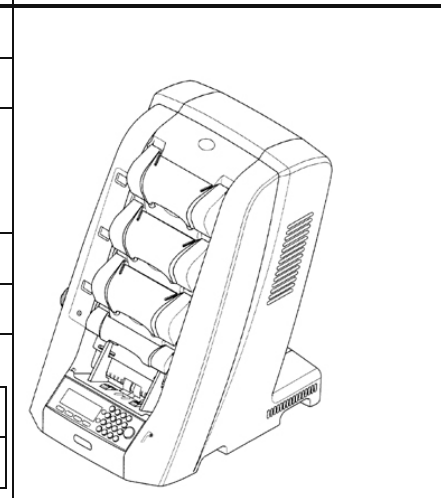

Design Number	217234	
Class	19-02	
1)De La Rue International Limited., De La Rue House, Jays Close, Viabes, Basingstoke, Hampshire Rg 22 4bs, Uk.		
Date of Registration	21/07/2008	
Title	Apparatus For Sorting Banknotes	
Priority		
Priority Number	Date	Country
000867361	24/01/2008	OHIM



Design Number	219488	
Class	02-02	
1)Charming Apparels (P) Ltd., 402-405, 1st Floor, Main Road, Chandni Chowk, Delhi-110 006, India.		
Date of Registration	30/10/2008	
Title	Dress Material	
Priority NA		
Design Number	221033	
Class	23-02	
1)Hindustan Sanitaryware & Industries Limited, Bahadurgarh-124507, Haryana, India.		
Date of Registration	02/02/2009	
Title	Urinal	
Priority NA		
Design Number	221181	
Class	23-04	
1)Crompton Greaves Limited., 6th Floor, Cg House, Dr Annie Besant Road, Worli, Mumbai-400 030, Maharashtra, India.		
Date of Registration	12/02/2009	
Title	Table Fan	
Priority NA		