



## ***CONTINUED FROM PART- 2***

### **INTRODUCTION**

In view of the recent amendment made in the Designs (Amendment) Rules, 2008 with effect from 17/06/2008, Publication of the matter relating to Designs is being published in the Official Journal of The Patent Office. This Journal is being published on weekly basis on every Friday covering the various proceedings on Designs as required according to the provisions of under Rule 22, 25, 27 and 39 of the Design (Amendment) Rules, 2008. All the enquiries on this Official Journal and other information as required by the public should be addressed to the Controller General of Patents, Designs & Trade Marks. Suggestions and comments are requested from all quarters so that the content can be enriched.

## REGISTRATION OF DESIGNS

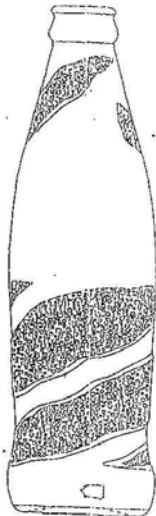

The following designs have been registered. They are now open for public inspection. In the following each entry the Date of Registration is shown. The Priority Number, Priority Date and Priority Country are also shown

<b>Design Number</b>	178185	
<b>Class</b>	09-01	
<b>1)Pepsico Inc</b> 700 Anderson Hill Road, Purchase, New York 10577, SA		
<b>Date of Registration</b>	28/12/1998	
<b>Title</b>	Beverage Bottle	
<b>Priority NA</b>		
<b>Design Number</b>	216926	
<b>Class</b>	05-05	
<b>1)Biba Apparels Pvt. Ltd.,</b> 45-54, "Whitehall", Kemps Corner, 143, A.K.Marg, Mumbai-400 036. Maharashtra, India.		
<b>Date of Registration</b>	30/06/2008	
<b>Title</b>	Textile Fabric	
<b>Priority NA</b>		
<b>Design Number</b>	220241	
<b>Class</b>	11-01	
<b>1)Jewelex India Pvt. Ltd.,</b> Plot 56 B, Seepz, Andheri East, Mumbai-400 096, India		
<b>Date of Registration</b>	16/12/2008	
<b>Title</b>	Gem Stone	
<b>Priority NA</b>		

<b>Design Number</b>	220445	
<b>Class</b>	26-05	
<b>1)Indian Oil Corporation Limited</b> Research & Development Centre, Sector-13, Faridabad-121007, Haryana, India		
<b>Date of Registration</b>	24/12/2008	
<b>Title</b>	Wick Lamp	
<b>Priority NA</b>		

<b>Design Number</b>	198033	
<b>Class</b>	07-02	
<b>1)Dart Industries Inc</b> Delaware,U.S.A.Of 14901,South Orange Blossom Trail Orlando Florida 32837 U.S.A		
<b>Date of Registration</b>	29/12/2004	
<b>Title</b>	Container	
<b>Priority</b>		
Priority Number	Date	Country
29/209,844	22/07/2004	U.S.A.

<b>Design Number</b>	219723	
<b>Class</b>	24-01	
<b>1)Alembic Limited</b> Alembic Road, Alembic Campus, Vadodara-390003, Gujarat, India		
<b>Date of Registration</b>	17/11/2008	
<b>Title</b>	Precipitator	
<b>Priority NA</b>		

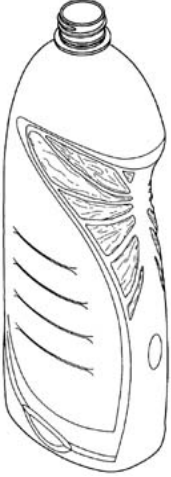
<b>Design Number</b>	219744	
<b>Class</b>	06-04	
<b>1)Ultra Fab India Pvt. Ltd.,</b> Survey No.263/3/4, Plot No.12, Sayali Silvassa, Dadra Nagar Haveli. Gujarat-India		
<b>Date of Registration</b>	18/11/2008	
<b>Title</b>	Furniture	
<b>Priority NA</b>		
<b>Design Number</b>	219777	
<b>Class</b>	23-01	
<b>1)M/S. Shakti Industries</b> 40, Nageshwar Estate, Opp. Javahar Nagar, Amreiwadi, Ahmedabad- 380026, Gujarat, India		
<b>Date of Registration</b>	20/11/2008	
<b>Title</b>	window Flange	
<b>Priority NA</b>		
<b>Design Number</b>	220134	
<b>Class</b>	09-01	
<b>1)Hindustan Unilever Limited.,</b> Hindustan Lever House 165/166, Backbay Reclamation, Mumbai-400 020, Maharashtra, India.		
<b>Date of Registration</b>	10/12/2008	
<b>Title</b>	Bottle	
<b>Priority NA</b>		

<b>Design Number</b>	218959	
<b>Class</b>	14-03	
<b>1)M/s. King Multitech Global Pvt. Limited</b> G.T. Road, Near Octroi Post, Sahnewal, Ludhiana-141120 (Punjab) (India)		
<b>Date of Registration</b>	03/10/2008	
<b>Title</b>	Cell Chip	
<b>Priority NA</b>		
<b>Design Number</b>	220911	
<b>Class</b>	23-01	
<b>1)Klaus Waren Fixtures Pvt. Ltd.,</b> 285, Paek View, 1st Floor, Flat No. 9, B.A.K Anjan Marg, Opp. Napoo Garden, Matunga (Central Railway) (E), Mambai-400 019, Maharashtra, India.		
<b>Date of Registration</b>	23/01/2009	
<b>Title</b>	Basin Mixer	
<b>Priority NA</b>		
<b>Design Number</b>	220912	
<b>Class</b>	23-01	
<b>1)Klaus Waren Fixtures Pvt. Ltd.,</b> 285, Paek View, 1st Floor, Flat No. 9, B.A.K Anjan Marg, Opp. Napoo Garden, Matunga (Central Railway) (E), Mumbai-400 019, Maharashtra, India.		
<b>Date of Registration</b>	23/01/2009	
<b>Title</b>	Basin Mixer	
<b>Priority NA</b>		

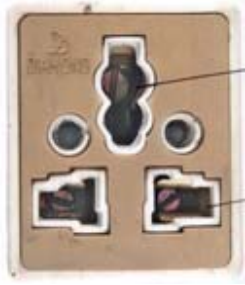
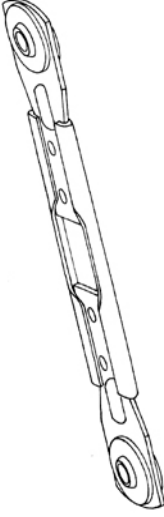
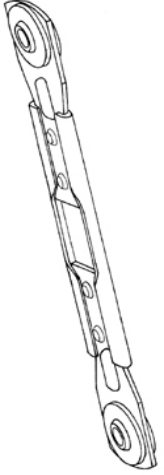
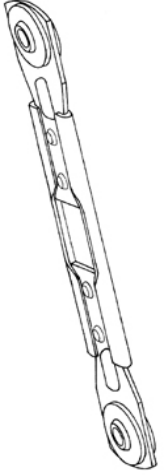
<b>Design Number</b>	220929		
<b>Class</b>	13-03		
<b>1)Diamond Enterprises</b> RZ-283/57, West Block, Vishnu Garden, New Delhi-110018			
<b>Date of Registration</b>	27/01/2009		
<b>Title</b>	Multiplug		
<b>Priority NA</b>			
<b>Design Number</b>	221074		
<b>Class</b>	12-16		
<b>1)Doga S.A.,</b> Carretera N-II, Km. 583, Abrera-08630, Barcelona, Spain.			
<b>Date of Registration</b>	04/02/2009		
<b>Title</b>	Windscreen Wipers		
<b>Priority</b>			
Priority Number	Date	Country	
000982871-0002	05/08/2008	EUROPEAN UNION	
<b>Design Number</b>			
<b>Class</b>			
<b>1)Doga S.A.,</b> Carretera N-II, Km. 583, Abrera-08630, Barcelona, Spain.			
<b>Date of Registration</b>			
<b>Title</b>			
<b>Priority</b>			
Priority Number	Date	Country	
000982871-0003	05/08/2008	EUROPEAN UNION	

<b>Design Number</b>	221115	
<b>Class</b>	13-03	
<b>1)Crompton Greaves Limited,</b> 6th Floor, CG House, Dr Annie Besant Road, Worli, Mumbai 400030, Maharashtra, India		
<b>Date of Registration</b>	09/02/2009	
<b>Title</b>	Fan Regulator	
<b>Priority NA</b>		
<b>Design Number</b>	221117	
<b>Class</b>	23-03	
<b>1)Crompton Greaves Limited.,</b> 6th Floor, Cg House, Dr Annie Besant Road, Worli, Mumbai-400 030, Maharashtra, India.		
<b>Date of Registration</b>	09/02/2009	
<b>Title</b>	"Geyser"	
<b>Priority NA</b>		
<b>Design Number</b>	221126	
<b>Class</b>	12-15	
<b>1)Ceat Limited.,</b> Ceat Mahal, 463, Anne Besant Road, Worli, Mumbai-400 030, India.		
<b>Date of Registration</b>	10/02/2009	
<b>Title</b>	Motorcycle Tyre	
<b>Priority NA</b>		

<b>Design Number</b>	210915
<b>Class</b>	08-05
<b>1)AIR BRIDGE SCAFFOLDING PVT. LTD.</b> ICHAPUR KAMARDANGA, HOWRAH-711104	
<b>Date of Registration</b>	20/06/2007
<b>Title</b>	Span Beam
<b>Priority NA</b>	



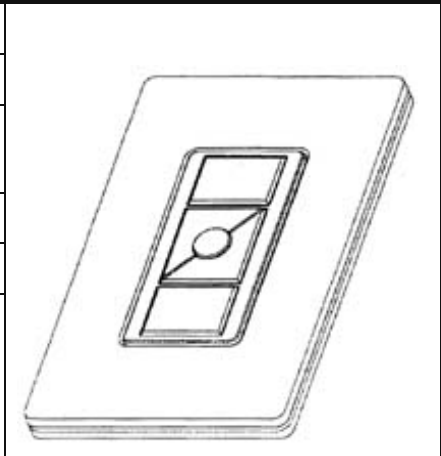

<b>Design Number</b>	218975	
<b>Class</b>	14-03	
<b>1)Lutron Electronics Company, Inc.,</b> 7200 Suter Road Coopersburg, Pennsylvania 18036-1299, USA		
<b>Date of Registration</b>	03/10/2008	
<b>Title</b>	Wall Remote Control Device	
<b>Priority</b>		
Priority Number	Date	Country
29/306,225	04/04/2008	U.S.A.



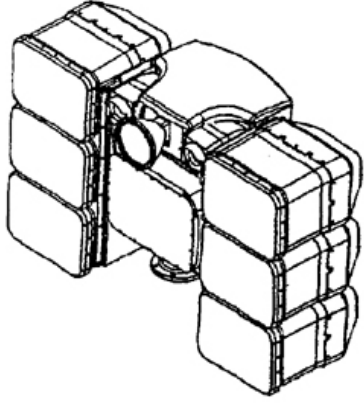

<b>Design Number</b>	219007	
<b>Class</b>	02-02	
<b>1)Charming Apparels (P) Ltd.,</b> 402-405, 1st Floor, Main Road, Chandni Chowk, Delhi-110 006, India.		
<b>Date of Registration</b>	06/10/2008	
<b>Title</b>	Dress Material	
<b>Priority NA</b>		

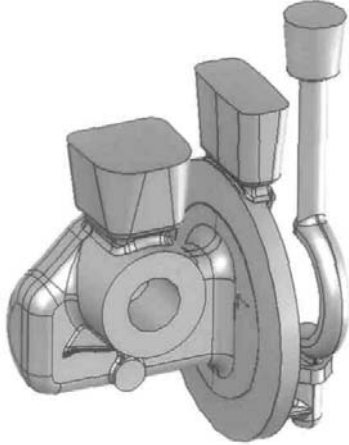

<b>Design Number</b>	219249		
<b>Class</b>	10-05		
<b>1)Moog Inc.,</b> Jamison Road, East Aurora, New York 14052			
<b>Date of Registration</b>	16/10/2008		
<b>Title</b>	Six Speaker Remote Acoustic		
<b>Priority</b>			
Priority Number	Date	Country	
29/307, 440	21/04/2008	U.S.A.	
<b>Design Number</b>	219335		
<b>Class</b>	21-02		
<b>1)Sharma Exports</b> B-16, Sports & Surgical Complex, Kapurthala Road, Jalandhar-144021 (Punjab) India			
<b>Date of Registration</b>	20/10/2008		
<b>Title</b>	BALL (TOY)		
<b>Priority NA</b>			
<b>Design Number</b>	209206		
<b>Class</b>	08-05		
<b>1)CROMPTOM GREAVES LIMITED</b> 6TH FLOOR.CG HOUSE, DR ANNIE BESANT ROAD, WORLI, MUMBAI â€“400030, MAHARASHTRA, INDIA			
<b>Date of Registration</b>	30/03/2007		
<b>Title</b>	METAL CASTING FOR CIRCUIT BREAKER		
<b>Priority NA</b>			

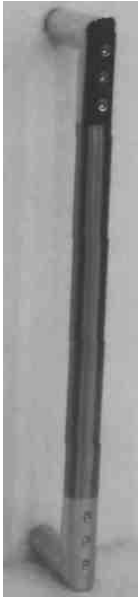
<b>Design Number</b>	215723	
<b>Class</b>	26-03	
<b>1)Crompton Greaves Limited,</b> 6th Floor, CG House, Dr Annie Besant Road, Worli, Mumbai 400030, Maharashtra, India		
<b>Date of Registration</b>	31/03/2008	
<b>Title</b>	Street Lighting Fixture	
<b>Priority NA</b>		
<b>Design Number</b>	218105	
<b>Class</b>	09-01	
<b>1)Zenna Plastics Limited</b> Plot No-19-A,Mira Co-Op.Industrial Estate Western Express Highway Mira-401104 Thane,Maharashtra,India		
<b>Date of Registration</b>	25/08/2008	
<b>Title</b>	Bottle	
<b>Priority NA</b>		
<b>Design Number</b>	218134	
<b>Class</b>	08-06	
<b>1)Shree Technocast</b> Aji G.I.D.C.Shed No.K-1-242/5,Maltech Chowk,Rajkot,Gujarat(India)		
<b>Date of Registration</b>	27/08/2008	
<b>Title</b>	Handle	
<b>Priority NA</b>		

<b>Design Number</b>	218135	
<b>Class</b>	08-06	
<b>1)Shree Technocast</b> Aji G.I.D.C.Shed No.K-1-242/5,Maltech Chowk,Rajkot,Gujarat(India)		
<b>Date of Registration</b>	27/08/2008	
<b>Title</b>	Handle	
<b>Priority NA</b>		
<b>Design Number</b>	218137	
<b>Class</b>	13-03	
<b>1)Shree Technocast</b> Aji G.I.D.C.Shed No.K-1-242/5 Maltech Chowk Rajkot,Gujarat (India)		
<b>Date of Registration</b>	27/08/2008	
<b>Title</b>	Cable Holder	
<b>Priority NA</b>		
<b>Design Number</b>	218138	
<b>Class</b>	08-06	
<b>1)Shree Technocast</b> Aji G.I.D.C.Shed No.K-1-242/5,Maltech Chowk,Rajkot,Gujarat (India)		
<b>Date of Registration</b>	27/08/2008	
<b>Title</b>	Handle	
<b>Priority NA</b>		

<b>Design Number</b>	218139	
<b>Class</b>	08-06	
<b>1)Shree Technocast</b> Aji G.I.D.C.Shed No.K-1-242/5,Maltech Chowk, Rajkot,Gujarat (India)		
<b>Date of Registration</b>	27/08/2008	
<b>Title</b>	Handle	
<b>Priority NA</b>		
<b>Design Number</b>	218140	
<b>Class</b>	08-06	
<b>1)Shree Technocast</b> Aji G.I.D.C.Shed No.K-1-242/5,Maltech Chowk,Rajkot,Gujarat,(India)		
<b>Date of Registration</b>	27/08/2008	
<b>Title</b>	Handle	
<b>Priority NA</b>		
<b>Design Number</b>	218141	
<b>Class</b>	08-06	
<b>1)Shree Technocast</b> AJI G.I.D.C., Shed No.K-1-242/5, Maltech chowk, Rajkot, Gujarat, India		
<b>Date of Registration</b>	27/08/2008	
<b>Title</b>	Handle	
<b>Priority NA</b>		
<b>Design Number</b>	218142	
<b>Class</b>	08-06	
<b>1)Shree Technocast</b>		

AJI G.I.D.C., Shed No.K-1-242/5, Maltech chowk, Rajkot, Gujarat, India		
<b>Date of Registration</b>	27/08/2008	
<b>Title</b>	Handle	
<b>Priority NA</b>		
<b>Design Number</b>	218143	
<b>Class</b>	08-06	
<b>1)Shree Technocast</b> AJI G.I.D.C., Shed No.K-1-242/5, Maltech chowk, Rajkot, Gujarat, India		
<b>Date of Registration</b>	27/08/2008	
<b>Title</b>	Handle	
<b>Priority NA</b>		
<b>Design Number</b>	218144	
<b>Class</b>	08-06	
<b>1)Shree Technocast</b> Aji G.I.D.C., Shed No. K-1-242/5, Maltech Chowk, Rajkot, Gujarat, India		
<b>Date of Registration</b>	27/08/2008	
<b>Title</b>	Handle	
<b>Priority NA</b>		

<b>Design Number</b>	218145	
<b>Class</b>	08-06	
<b>1)Shree Technocast</b> Aji G.I.D.C., Shed No. K-1-242/5, Maltech Chowk, Rajkot, Gujarat, India		
<b>Date of Registration</b>	27/08/2008	
<b>Title</b>	Handle	
<b>Priority NA</b>		
<b>Design Number</b>	218146	
<b>Class</b>	08-06	
<b>1)Shree Technocast</b> AJI G.I.D.C., Shed No.K-1-242/5, Maltech chowk, Rajkot, Gujarat, India		
<b>Date of Registration</b>	27/08/2008	
<b>Title</b>	Handle	
<b>Priority NA</b>		
<b>Design Number</b>	218239	
<b>Class</b>	07-02	
<b>1)Ravissant Pvt.Ltd.,</b> 50-51,Commerical Complex,New Friends Colony,New Delhi-110065 India		
<b>Date of Registration</b>	29/08/2008	
<b>Title</b>	Milk Pot	
<b>Priority NA</b>		

<b>Design Number</b>	199007	
<b>Class</b>	08-05	
<b>1)World Wide Welding Inc</b> 3705 Centre Circle, Fort Mill, South Carolina 29715-9753, USA		
<b>Date of Registration</b>	24/03/2005	
<b>Title</b>	Grease Gun Head	
<b>Priority</b>		
Priority Number	Date	Country
29/214,310	30/09/2004	U.S.A.



<b>Design Number</b>	199008	
<b>Class</b>	08-05	
<b>1)World Wide Welding Inc.,</b> 3705 Centre Circle, Fort Mill, South Carolina 29715-9753, USA		
<b>Date of Registration</b>	24/03/2005	
<b>Title</b>	Grease Gun Head	
<b>Priority</b>		
Priority Number	Date	Country
29/214,314	30/09/2004	U.S.A.

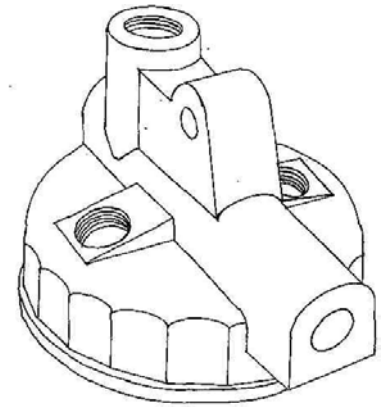

<b>Design Number</b>	199013	
<b>Class</b>	23-01	
<b>1)World Wide Welding Inc.</b> 3705 Centre Circle, Fort Mill, South Carolina 29715-9753, U.S.A.		
<b>Date of Registration</b>	24/03/2005	
<b>Title</b>	Pump Head	
<b>Priority</b>		
Priority Number	Date	Country
29/214,309	30/09/2004	U.S.A.

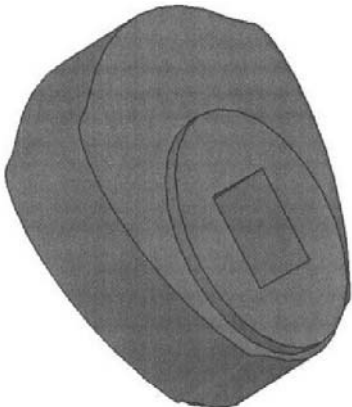

<b>Design Number</b>	210112	
<b>Class</b>	07-07	
<b>1)WELMADE LOCKING SYSTEMS PVT. LTD</b> J-61, M.I.D.C., BHOSARI, PUNE-411026, MAHARASHTRA, INDIA.		
<b>Date of Registration</b>	10/05/2007	
<b>Title</b>	DRAWER LOCK	
<b>Priority NA</b>		

<b>Design Number</b>	210156	
<b>Class</b>	15-99	
<b>1)Q-CORE LTD.,</b> P.O.B. 3341, PETACH TIKVA 49130, ISRAEL.		
<b>Date of Registration</b>	13/11/2006	
<b>Title</b>	CAMSHAFT FOR INFUSION PERISTALTIC PUMP WITH TWO CRESCENT FORMS	
<b>Priority</b>		
<b>Priority Number</b>	<b>Date</b>	
43319	13/11/2006	Israel

<b>Design Number</b>	215169	
<b>Class</b>	04-02	
<b>1)Hindustan Unilever Limited.,</b> Hindustan Lever House 165/166, Backbay Reclamation, Mumbai-400 020, Maharashtra, India.		
<b>Date of Registration</b>	07/03/2008	
<b>Title</b>	Toothbrush	
<b>Priority NA</b>		

<b>Design Number</b>	219435	
<b>Class</b>	15-05	
<b>1)Koninklijke Philips Electronics N. V.</b> Groenewoudseweg 1, 5621 BA Eindhoven, The Netherlands		
<b>Date of Registration</b>	24/10/2008	
<b>Title</b>	Vacuum Cleaner With Head	
<b>Priority</b>		
Priority Number	Date	Country
000924816-0001	25/04/2008	OHIM

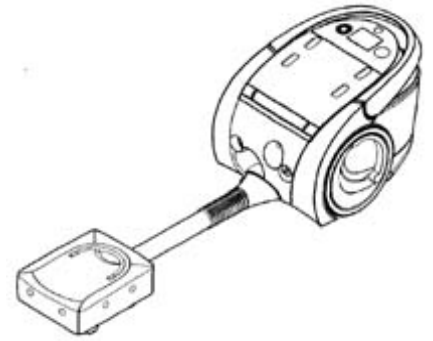

<b>Design Number</b>	221464	
<b>Class</b>	05-05	
<b>1)Charming Apparels (P) Ltd.,</b> 402-405, 1st Floor, Main Road, Chandni Chowk, Delhi-110006, India		
<b>Date of Registration</b>	27/02/2009	
<b>Title</b>	Textile Fabric	
<b>Priority NA</b>		

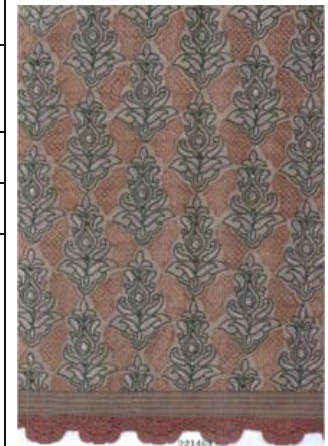



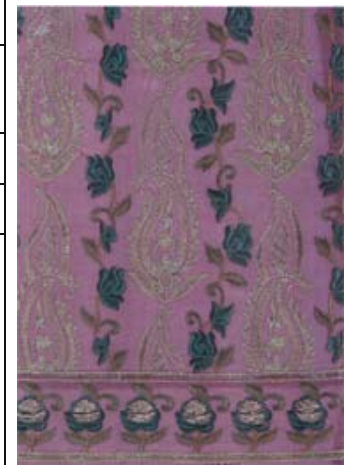



<b>Design Number</b>	221468	
<b>Class</b>	05-05	
<b>1)Charming Apparels (P) Ltd.,</b> 402-405, 1st Floor, Main Road, Chandni Chowk, Delhi-110 006, India.		
<b>Date of Registration</b>	27/02/2009	
<b>Title</b>	Textile Fabric	
<b>Priority NA</b>		



<b>Design Number</b>	218398	
<b>Class</b>	06-13	
<b>1)Rosebys Interiors India Limited</b> A-17, Sector 58, Noida-201303, Uttar Pradesh, India.		
<b>Date of Registration</b>	05/09/2008	
<b>Title</b>	Pillow Case	
<b>Priority NA</b>		
<b>Design Number</b>	218400	
<b>Class</b>	06-13	
<b>1)Rosebys Interiors India Limited</b> A-17, Sector 58, Noida-201303, Uttar Pradesh		
<b>Date of Registration</b>	05/09/2008	
<b>Title</b>	Pillow case	
<b>Priority NA</b>		
<b>Design Number</b>	218401	
<b>Class</b>	06-13	
<b>1)Rosebys Interiors India Limited</b> A-17, Sector 58, Noida-201303, Uttar Pradesh		
<b>Date of Registration</b>	05/09/2008	
<b>Title</b>	Pillow Case	
<b>Priority NA</b>		

<b>Design Number</b>	220666	
<b>Class</b>	14-02	
<b>1)Su-Kam Power Systems Ltd.,</b> Plot No. Wz-1401/2, Nangal Raya, New Delhi-110 046, India.		
<b>Date of Registration</b>	05/01/2009	
<b>Title</b>	Battery	
<b>Priority NA</b>		
<b>Design Number</b>	220668	
<b>Class</b>	14-02	
<b>1)Innoviti Embedded Solutions Pvt. Ltd.,</b> Ngr The Edge, No. 41, 2nd & 3rd Floor, 3rd Main, 5th Cross, Saibaba Mandir Road, Cambridge Layout, Halasuru, Bangalore-560 008, Karnataka, India.		
<b>Date of Registration</b>	05/01/2009	
<b>Title</b>	Biometric Device	
<b>Priority NA</b>		
<b>Design Number</b>	220725	
<b>Class</b>	23-04	
<b>1)Surindra Polymers</b> B-6, Dside Complex, Rohtak Road, Nangloi, Delhi-110 041, India		
<b>Date of Registration</b>	09/01/2009	
<b>Title</b>	Cooler Body	
<b>Priority NA</b>		

<b>Design Number</b>	220790	
<b>Class</b>	09-03	
<b>1)Balmer Lawrie &amp; Company Ltd.,</b> 21, Netaji Subhas Road, Kolkata-700 001, WB, India.		
<b>Date of Registration</b>	15/01/2009	
<b>Title</b>	Barrel	
<b>Priority NA</b>		
<b>Design Number</b>	220791	
<b>Class</b>	09-03	
<b>1)Balmer Lawrie &amp; Company Ltd.,</b> 21, Netaji Subhas Road, Kolkata-700 001, WB, India.		
<b>Date of Registration</b>	15/01/2009	
<b>Title</b>	Barrel	
<b>Priority NA</b>		
<b>Design Number</b>	220792	
<b>Class</b>	09-03	
<b>1)Balmer Lawrie &amp; Company Ltd.,</b> 21, Netaji Subhas Road, Kolkata-700 001, WB, India.		
<b>Date of Registration</b>	15/01/2009	
<b>Title</b>	Barrel	
<b>Priority NA</b>		

<b>Design Number</b>	220793	
<b>Class</b>	09-03	
<b>1)Balmer Lawrie &amp; Company Ltd.,</b> 21, Netaji Subhas Road, Kolkata-700 001, WB, India.		
<b>Date of Registration</b>	15/01/2009	
<b>Title</b>	Barrel	
<b>Priority NA</b>		
<b>Design Number</b>	220830	
<b>Class</b>	12-11	
<b>1)Voltan Industries.,</b> D-9, Textile Colony, Industrial Area-A, Ludhiana-141 003, Punjab, India.		
<b>Date of Registration</b>	19/01/2009	
<b>Title</b>	Triple Chain Wheel With Guard & Crank For Bicycle	
<b>Priority NA</b>		
<b>Design Number</b>	220859	
<b>Class</b>	05-05	
<b>1)Charming Apparels (P) Ltd.,</b> 402-405, 1st Floor, Main Road, Chandni Chowk, Delhi-110006, India		
<b>Date of Registration</b>	20/01/2009	
<b>Title</b>	Textile Fabric	
<b>Priority NA</b>		